

Plateau

Design – Böttcher & Kayser



JOHANSON



Introduction

Plateau is a product family that comprises sofas, armchairs and 'seating islands'. The individual pieces work well on their own but can also be combined in groups to create a more dynamic overall impression. The style is uncluttered and uncomplicated. Unnecessary details have been excluded to leave a design that evokes a sense of calm in whatever setting it dignifies.

Plateau has a terrace-like form. The asymmetric structure in each individual item of furniture creates a striking graphic expression. A sensation

of almost hovering in the air. Inviting and, for all its simplicity, spectacular,' say Böttcher-Kayser.

The upholstered elements are held in place by a metal frame, creating an eye-catching combination of varying levels. Plateau is also available without armrests. These can be replaced by a small table that provides a handy surface on which to stand a coffee cup, for example, or perhaps a small computer.

Plateau can be used in a variety of settings, such as waiting rooms and receptions, as a seat for several people in an exhibition hall, or at home in the lounge.



Designer

Böttcher & Kayser is a Berlin-based studio founded in 2007, working in the fields of consumer product, furniture, lighting and interior design. Moritz Böttcher and Nikolaus Kayser have been rewarded with several prestigious awards such as the Interior Innovation Award, several iF Design Awards and numerous Red Dot Awards – including the award, Best of the Best' in 2013. Their projects have been published in books and magazines around the world.



Models



1-seater armrest / table L/R*



2-seater armrest / table L/R*



3-seater armrest / table L/R*



Armchair armrest / table L/R*



Big Island with armrest L/R*

* Armrests and tables can be selected on the right or left.

Material

Seat - Upholstery materials

Johanson offers a very generous range of fabrics, leather and artificial leather from the most reputable suppliers in the world. Should any other material be desired despite the wide selection, it is also possible to suggest other materials. Johanson does not charge start-up costs for handling non-standard materials.

Multicolour - Finish RAL

Take part in Johanson's color range, 400 variants of different finishes are offered as standard on steel frames and metal details. Choose from all 192 RAL colors, alternatives are available both as solid finish (gloss 72) or Structure finish which has a matte, slightly textured elegant surface. In addition, 15 RAL colors with pearl finish and chrome are offered.

For all colours see www.johansondesign.com

192 Solid collection (gloss 72)

192 Structure collection (matte, textured surface)

15 Pearl finish collection and chrome.



Table top



Plateau-table

Table top with rounded corners.
Oak veneer, Black/ White stained oak veneer

Accessories



Phase

Black / white with details in black. 2 extensions



Power Hub

White with details in black. 3 extensions, 2 network



Phase

Black / white with details in black. 2 extensions, 2 USB

Pixel and Phase: USB with intelligent and powerful charge that meets high security requirements. Communicates with any brand for fastest possible charge, both for phones and tablets. Schuko coupling is delivered as standard.



Facts

Plateau-in detail

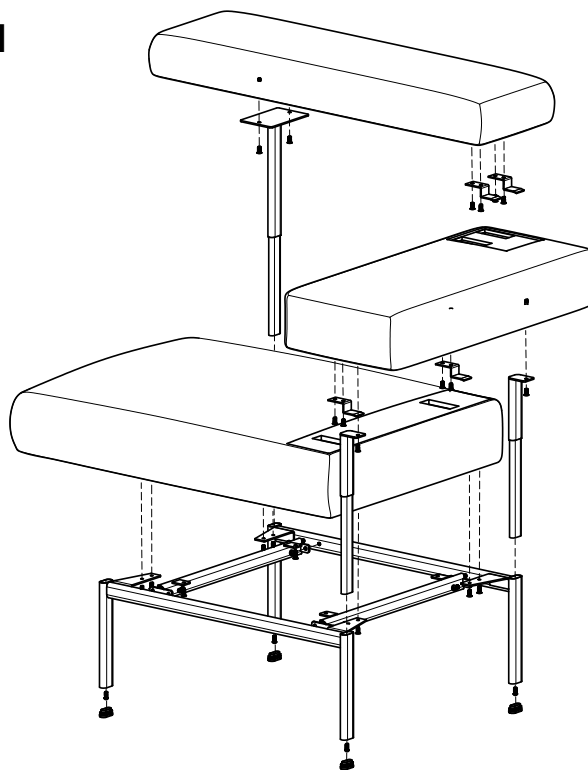

Separable



Material

- The seat, back and armrest are made out of plywood and the padding is PUR-foam with a density of 48kg/m³.
- The base is made out of finished/lacquered low carbon steel.

Certificate

- Fire certificate (Danak)

BIM - objects can be downloaded

at johansondesign.com

 3D Max

 Archicad

 Revit

 Autocad 2D

 Autocad 3D

 Sketchup

 pCon

Recycling

All steel parts are recyclable. Before we finish the chrome/lacquer all grease/oil is removed by alkaline wash and then sent for destruction. The lacquering is produced by electrostatic epoxy powder coating that gives a minimum of waste. The electrostatic chrome (chrome 3) is recyclable. The plastic parts that are used are recyclable by grinding. All upholstery and frames of synthetic material are totally without C.F.C. emissions. All glue is water based.

Material declaration

For more information about the product please download material declaration on our website, under Downloads à Product Information at www.johansondesign.com

Facts

Measurements cm

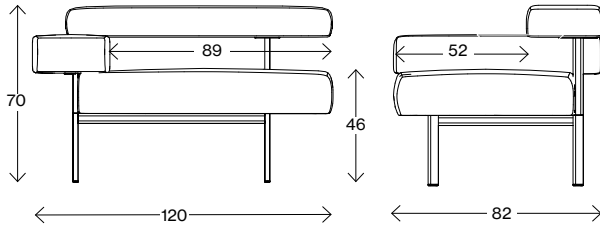

1-seater armrest

Weight (kg) -
Volume (m³) -

Measurements cm

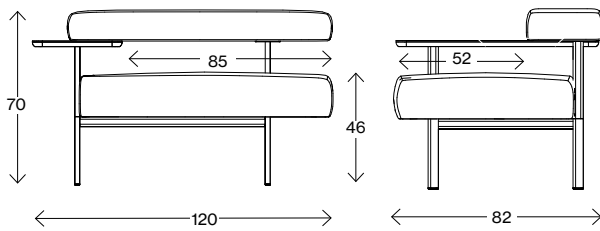

1-seater table

Weight (kg) -
Volume (m³) -

Measurements cm

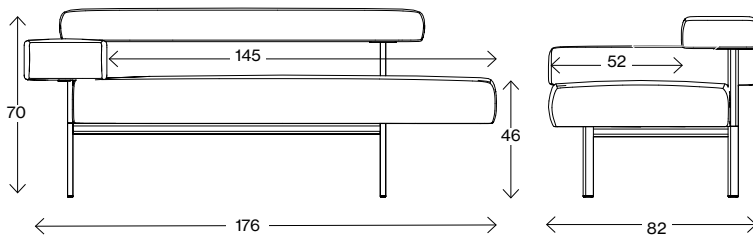

2-seater armrest

Weight (kg) -
Volume (m³) -

Measurements cm

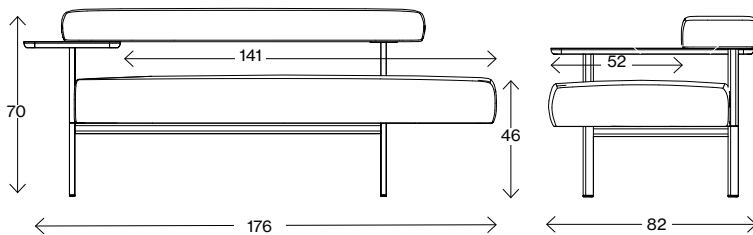

2-seater table

Weight (kg) -
Volume (m³) -

Facts

Measurements cm

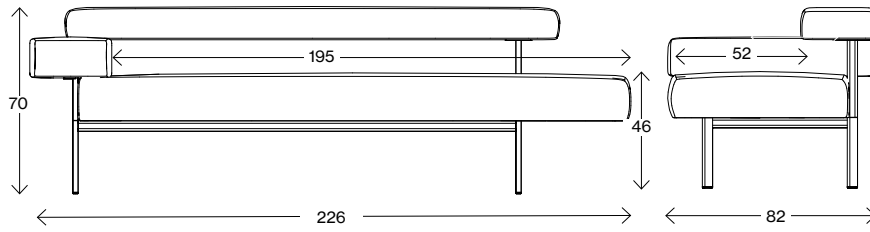

3-seater armrest

Weight (kg) -
Volume (m³) -

Measurements cm

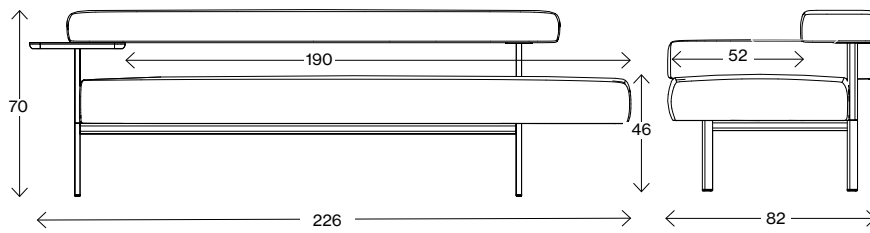

3-seater table

Weight (kg) -
Volume (m³) -

Measurements cm

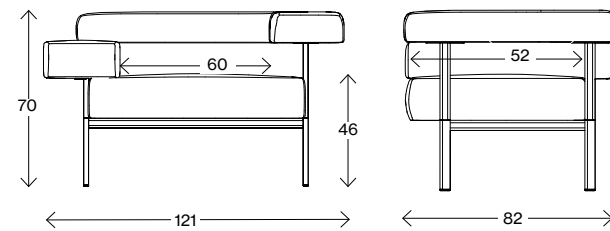

Armchair armrest

Weight (kg) -
Volume (m³) -

Measurements cm

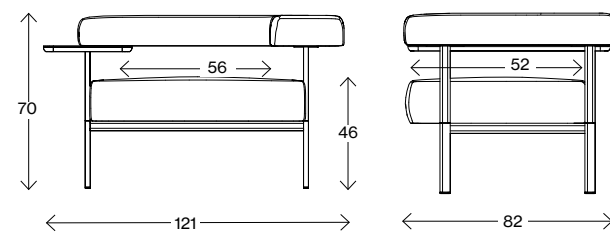

Armchair table

Weight (kg) -
Volume (m³) -

Measurements cm

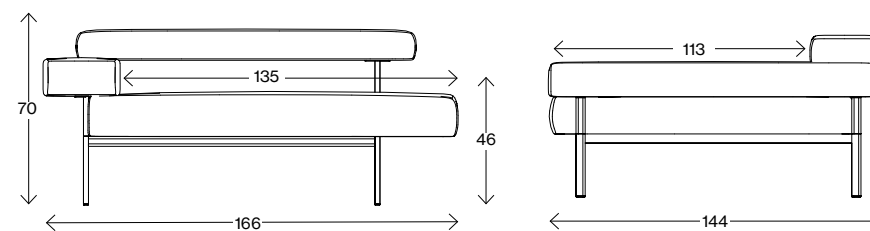

Big Island

Weight (kg) -
Volume (m³) -







JOHANSON

Johanson Design AB | Anders Anderssons Väg 7 | 285 35 Markaryd | Sweden
Tel +46-433 725 00 | www.johansondesign.com