

Family  
**Robbie**

Design – Böttcher & Kayser



**JOHANSON**



## Introduction

The idea behind Robbie was to design a chair that combines stackability with a genuinely attractive form. With this clearly in mind, the focus was on using as few components as possible and giving them a highly distinctive design. The aim was to create a chair that is simple in design, yet by no means anonymous in terms of personality. The eye-catching lines of Robbie attract attention in any setting.



## Designer

Böttcher & Kayser is a Berlin-based studio founded in 2007, working in the fields of consumer product, furniture, lighting and interior design. Moritz Böttcher and Nikolaus Kayser have been rewarded with several prestigious awards such as the Interior Innovation Award, several iF Design Awards and numerous Red Dot Awards – including the award, 'Best of the Best' in 2013. Their projects have been published in books and magazines around the world.



# Base

- 1 Choose model - base and execution
- 2 Choose model - seat and material, colour and texture
- 3 Choose accessories

## Sled base

## Swivel base

## Four leg base



09-46



03-46



08-46



09-46 with armrests (WA)



03-46 with wheels



Robbie-BS 65



Robbie-BS 80

# Seat & Material

1 Choose model - base and execution

2 Choose model - seat and material, colour and texture

3 Choose accessories

## Seats

---



Wooden seat



Half covered seat (HC)



Covered seat (C)



Wooden seat



Covered seat (C)

### Colors Wooden seat



Oak veneer



White stained  
veneer oak



Black stained  
oak veneer



Oak veneer stained  
in any RAL color

# Seat & Material

1 Choose model - base and execution

2 Choose model - seat and material, colour and texture

3 Choose accessories

---

## Seat - Upholstery materials

Johanson offers a very generous range of fabrics, leather and artificial leather from the most reputable suppliers in the world. Should any other material be desired despite the wide selection, it is also possible to suggest other materials. Johanson does not charge start-up costs for handling non-standard materials.

## Multicolour - Finish RAL

Take part in Johanson's color range, 400 variants of different finishes are offered as standard on steel frames and metal details. Choose from all 192 RAL colors, alternatives are available both as solid finish (gloss 72) or Structure finish which has a matte, slightly textured elegant surface. In addition, 15 RAL colors with pearl finish and chrome or polished aluminum are offered.

For all colours see [www.johansondesign.com](http://www.johansondesign.com)

**192 Solid collection** (gloss 72)

**192 Structure collection** (matte, textured surface)

**15 Pearl finish collection**

**Chrome** (08, 09- base)

**Polished aluminum** (03-base).





# Accessories

1 Choose model - base and execution

2 Choose model - seat and material, colour and texture

3 Choose accessories



## Connector

08-base



## Wheels

Wheels for 03-base in black, white and chrome.



## Connector

09-base

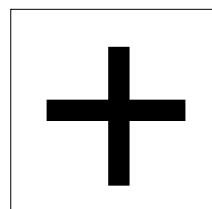

## Extra

Felt gliders  
Stacking protection



## Stacking trolley

Stackability for each chair can be found under facts.

# Facts

---

## Material

The seat is made in moulded CMHR foam (density 65kg) that meets the highest requirements for flammability (CMHR quality). The base is made of finished/lacquered metal.

## Certificate

- Fire certificate (Danak)

## Recycling

All steel parts are recyclable. Before we finish the chrome/lacquer all grease/oil is removed by alkaline wash and then sent for destruction. The lacquering is produced by electrostatic epoxy powder coating that gives a minimum of waste. The electrostatic chrome (chrome 3) is recyclable. The plastic parts that are used are recyclable by grinding. All upholstery and frames of synthetic material are totally without C.F.C. emissions. All glue is water based.

## BIM - objects can be downloaded

at [johansondesign.com](http://johansondesign.com)

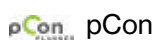
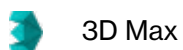

## Material declaration

For more information about the product please download material declaration on our website, under Downloads à Product Information at [www.johansondesign.com](http://www.johansondesign.com)



# Facts

Measurements cm

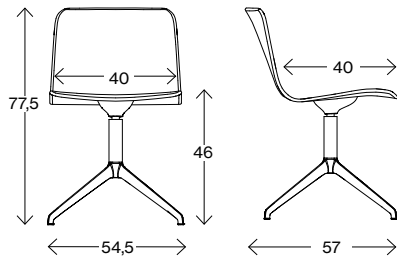

## Robbie 03-46

Weight (kg) 8,5  
Volume (m<sup>3</sup>) 0,27

Measurements cm

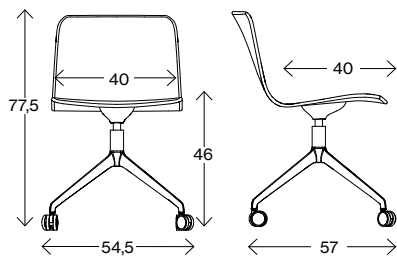

## Robbie 03-46 with wheels

Weight (kg) 8,5  
Volume (m<sup>3</sup>) 0,27

Measurements cm

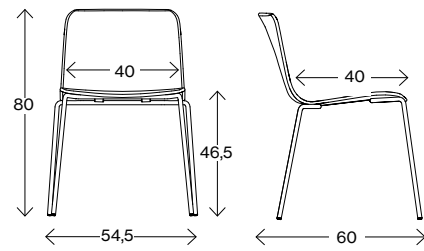

## Robbie 08-46

Weight (kg) 6,0  
Volume (m<sup>3</sup>) 0,25



Measurements cm

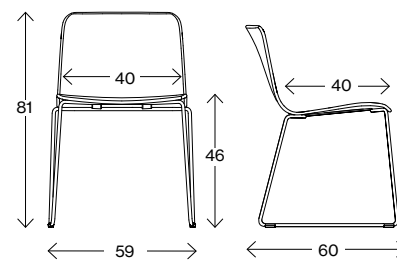

## Robbie 09-46

Weight (kg) 8,0  
Volume (m<sup>3</sup>) 0,25



Measurements cm

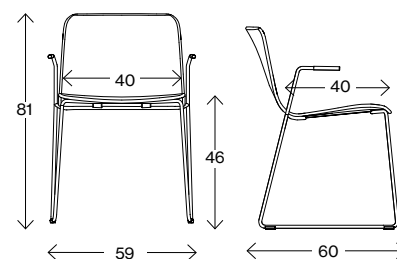

## Robbie 09-46 with armrests (WA)

Weight (kg) 9,0  
Volume (m<sup>3</sup>) 0,25



# Facts

---

Measurements cm

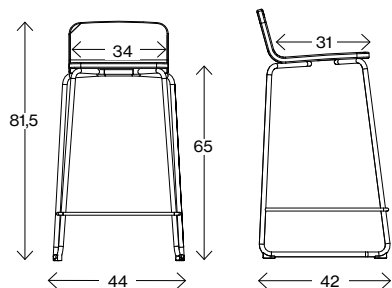

## Robbie BS 65

Weight (kg) 6,0  
Volume (m<sup>3</sup>) 0,192

Measurements cm

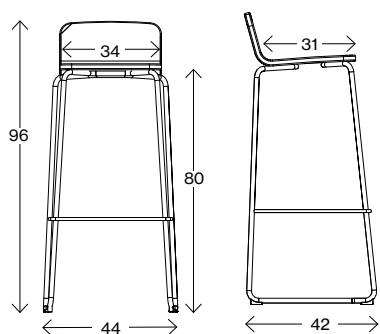

## Robbie BS 80

Weight (kg) 9,0  
Volume (m<sup>3</sup>) 0,243





# JOHANSON

---

Johanson Design AB | Anders Anderssons Väg 7 | 285 35 Markaryd | Sweden  
Tel +46-433 725 00 | [www.johansondesign.se](http://www.johansondesign.se)