

1

Put the frame together

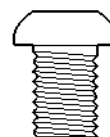
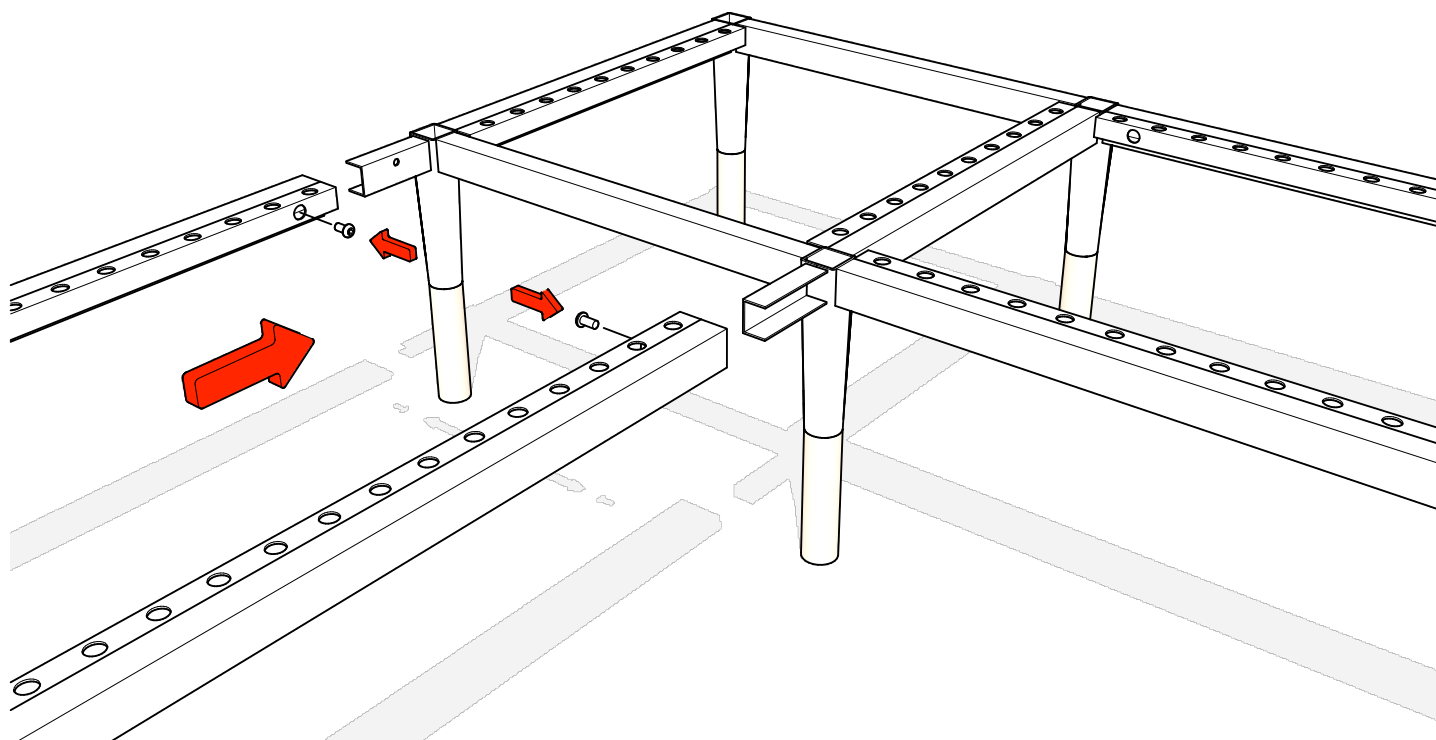

M8 x 12 mm

**JOHANSON**

2

The seat element to start with is marked "S"

Start building from right

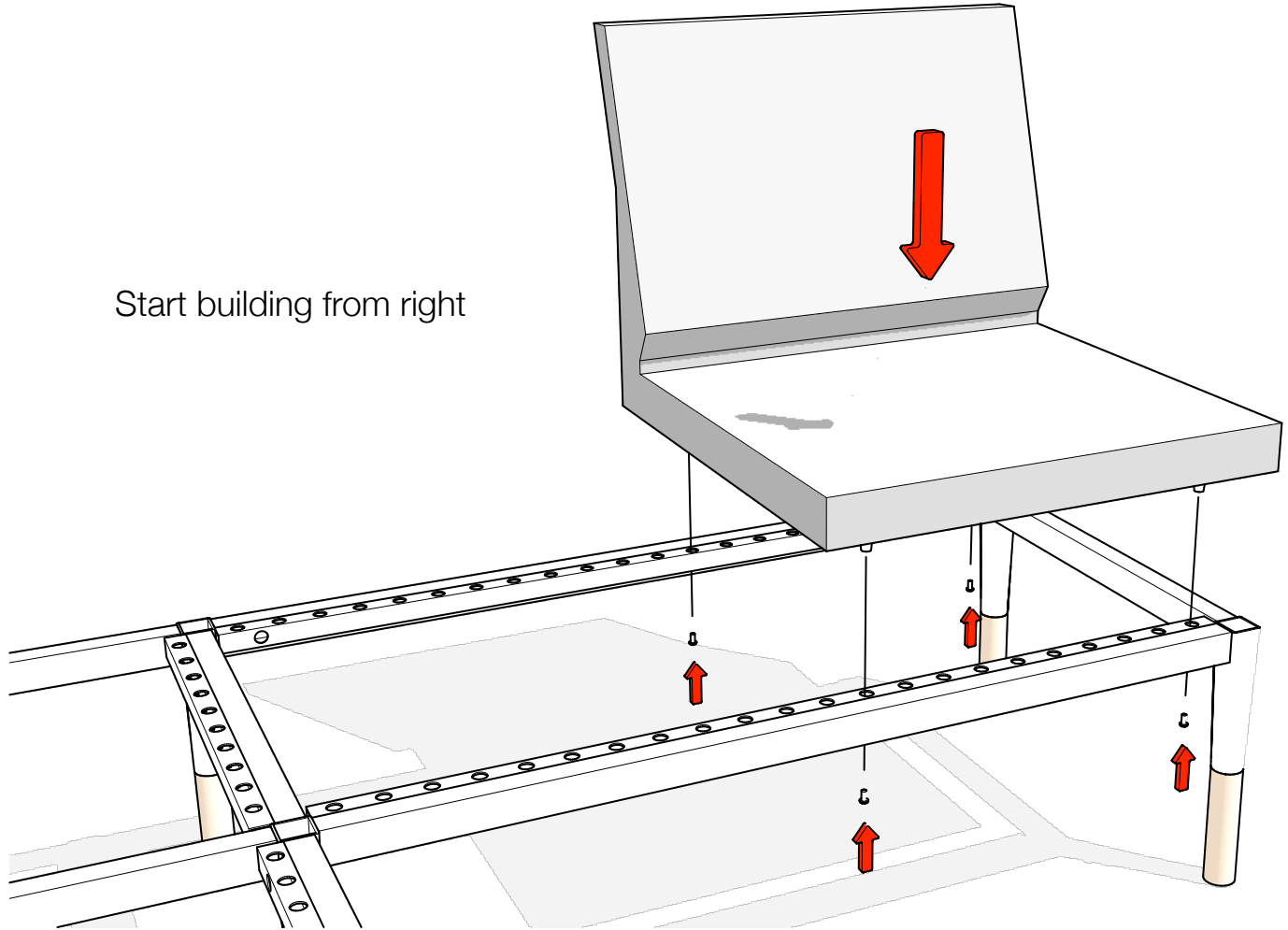

Lock each element with four screws



M6 x 12 mm

# 3

Fix hook in seat elementt

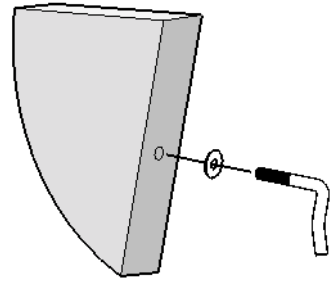

Hook the element into the fixed element

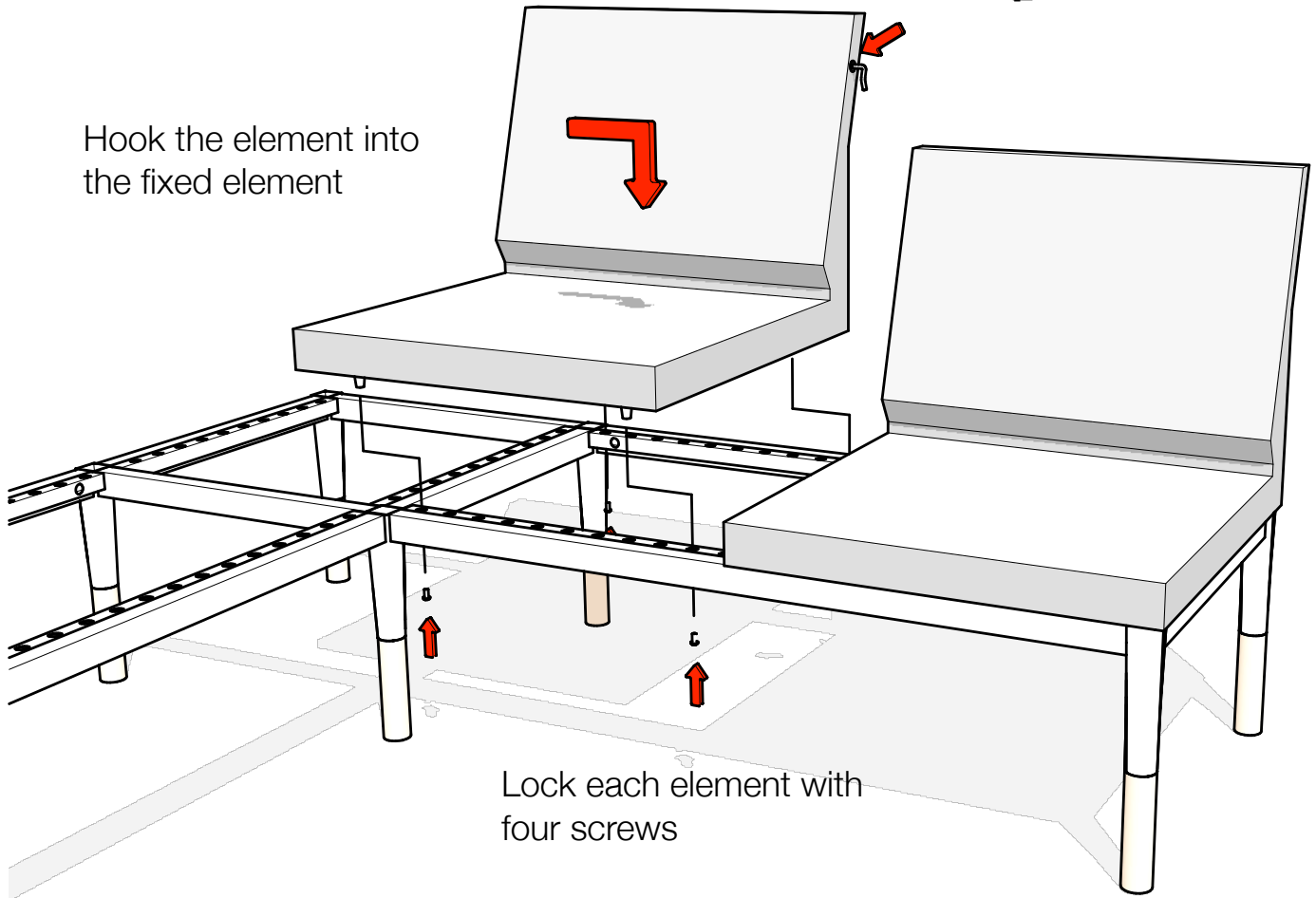

Lock each element with four screws

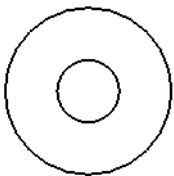

ø8 x ø22 x 1,5 mm

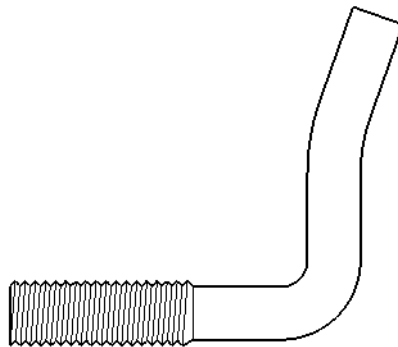

Hook M8 x 25 mm

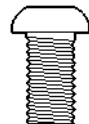

M6 x 12 mm

4

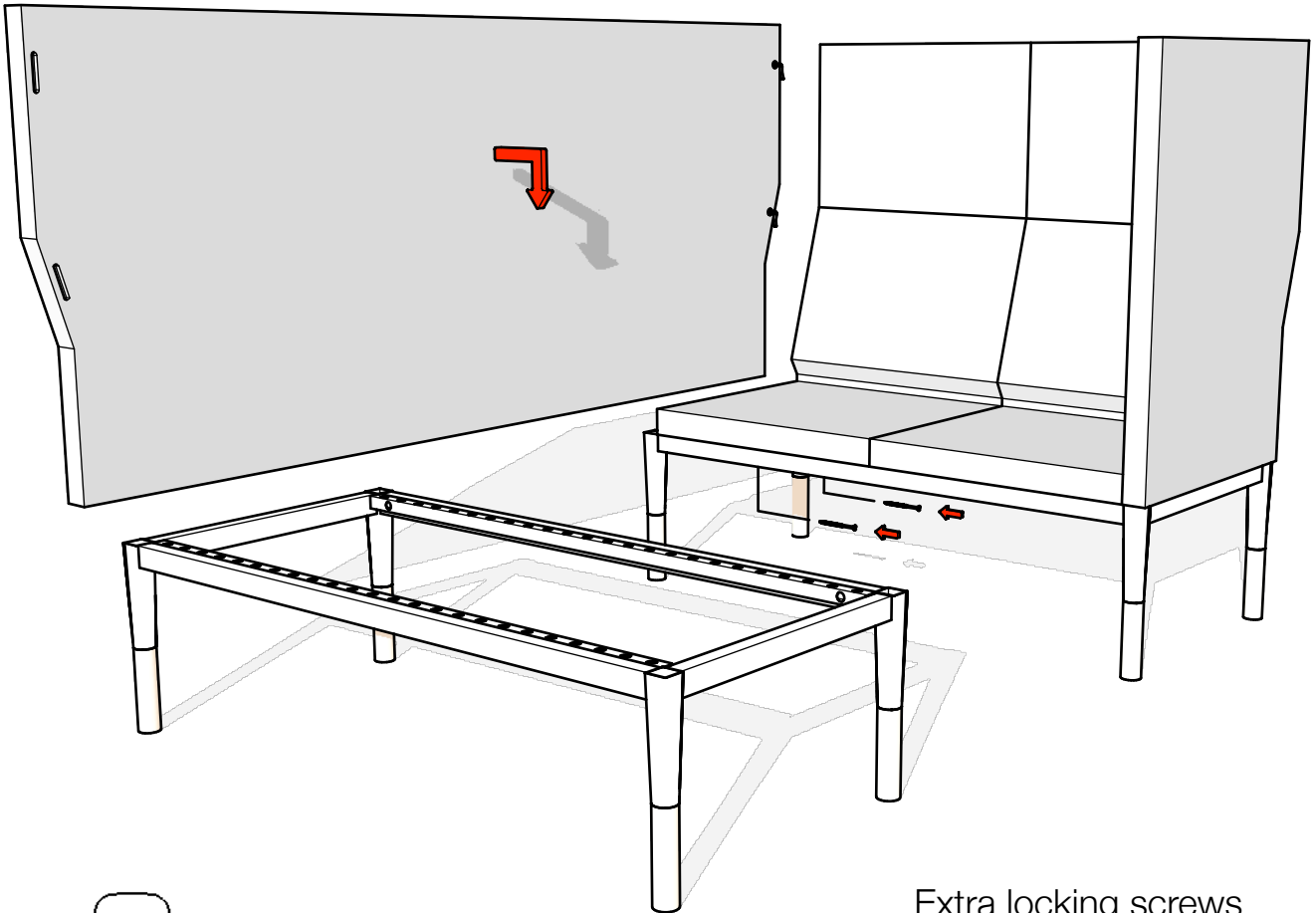

Extra locking screws  
into the wall in  
this setup

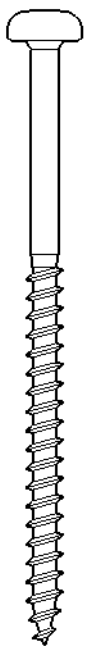

ø5 x 80 mm

5

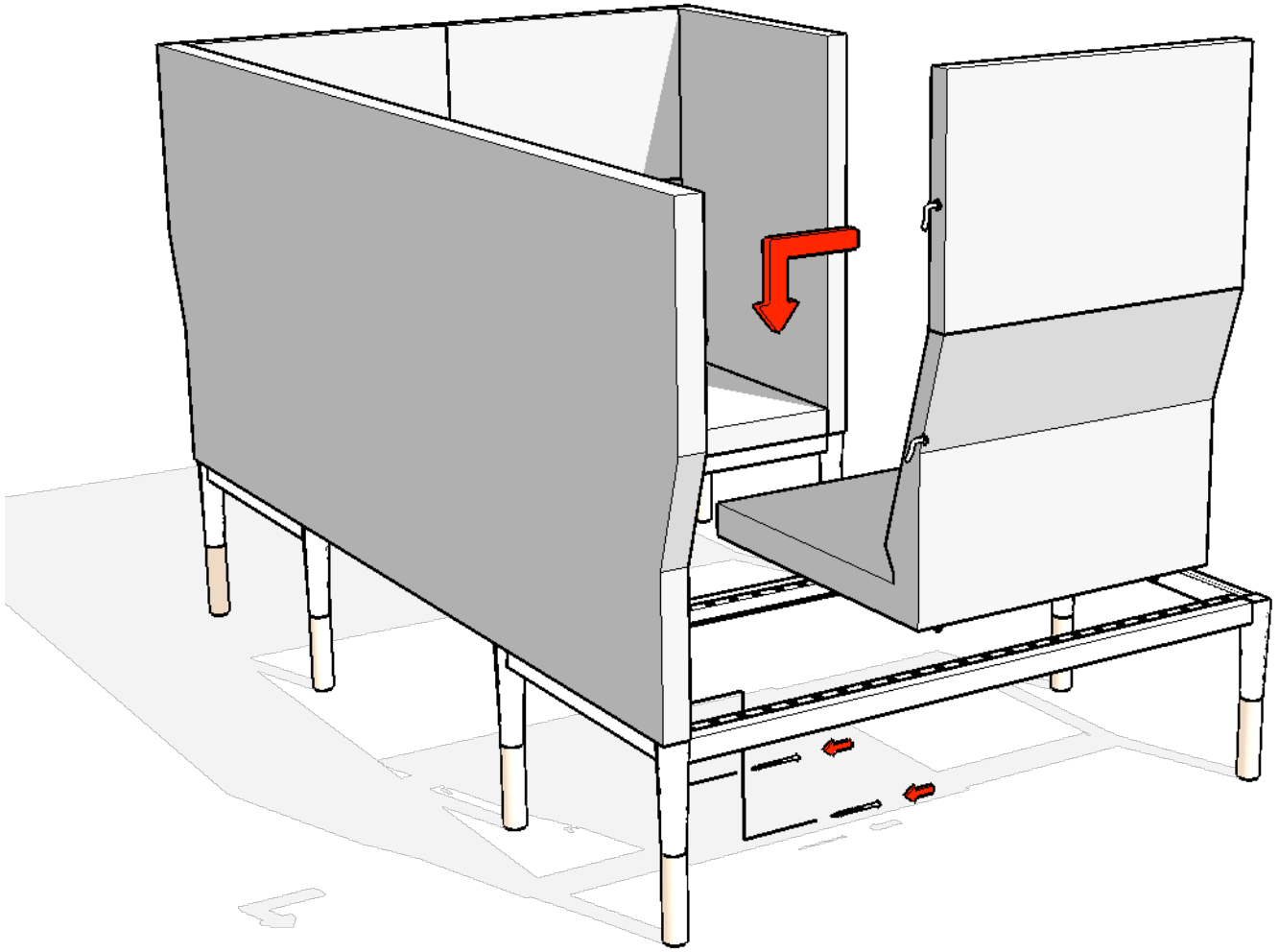

# 6

Screw supportplate to tabletop

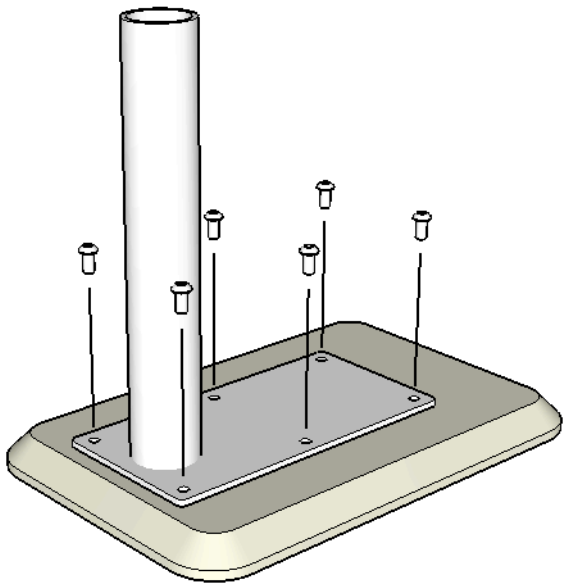

M6 x 12 mm

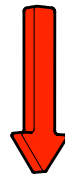

Fix table in armrest

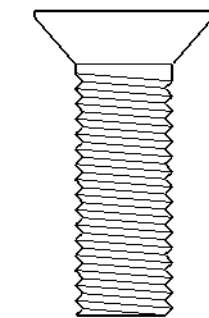
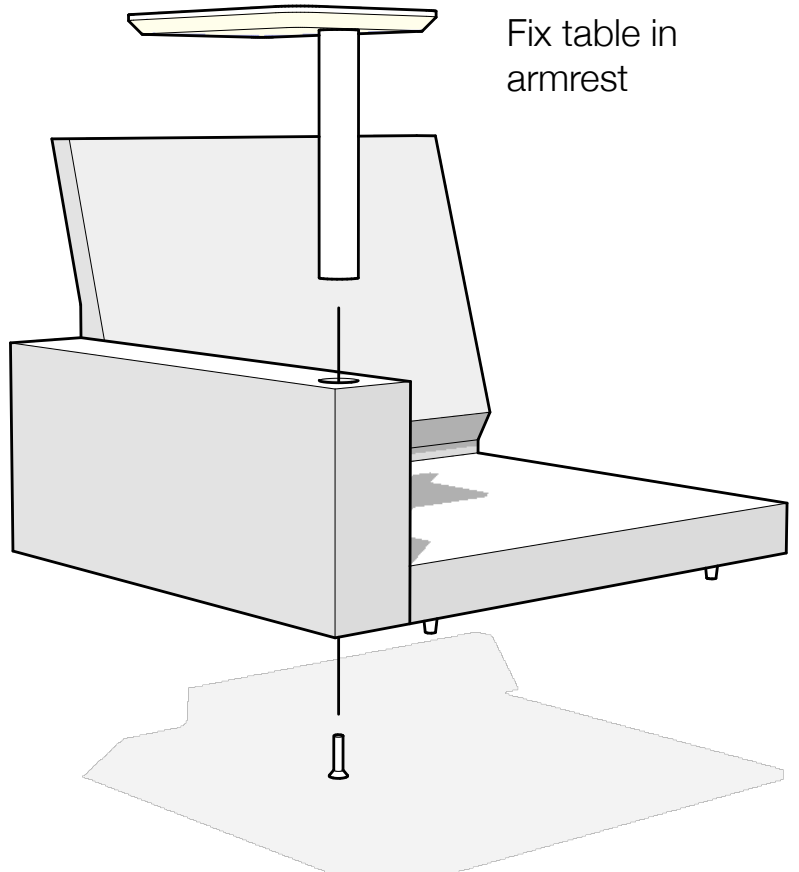

M12 x 40 mm

7

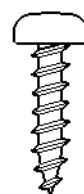
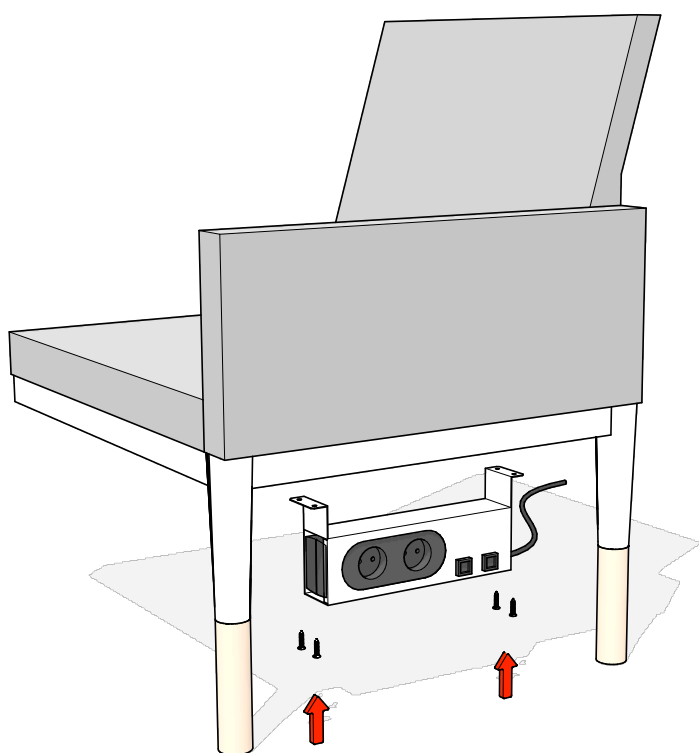
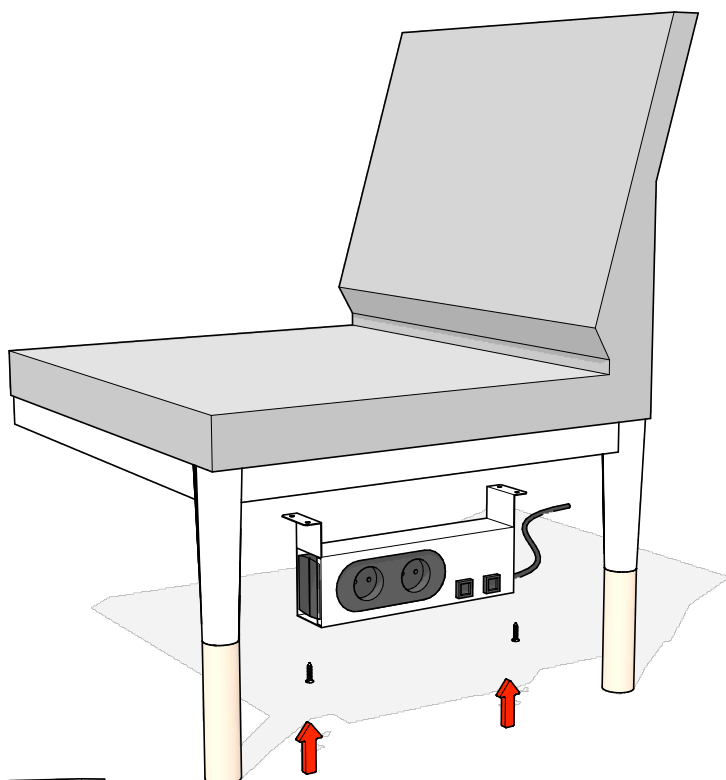

ø5 x 20 mm

For more information visit [www.johansondesign.com](http://www.johansondesign.com)



# JOHANSON

Johanson Design AB | Anders Anderssons väg 7 | 285 35 Markaryd | Sweden Tel +46 (0) 433 725 00