

Family
Stroll

Design – Böttcher & Kayser



JOHANSON



Introduction

Stroll builds on the concept of creating flexible settings and situations. Initially launched in 2020, the series has now been extended with more work tables, a serving trolley and side tables. All exhibit the playful expression that is typical of Stroll design and demonstrate the versatility, flexibility and stackability that are the hallmarks of this series.

Stroll-desks are available in different sizes and can easily be moved on wheels. When the desk is in use, the castors can easily be locked. The stackable design is a huge space-saving advantage when storing several desks – a useful solution for quickly adapting office furnishings to meet constantly shifting demands

in today's work environments. A meeting today, a workshop tomorrow, a conference later on.

Stroll-Butler is a flexible 'helping hand'. Working materials for the office, tools in the workshop, refreshments for the conference, or books and magazines in the reception. Stroll is your mobile 'personal assistant' in modern, flexible settings.

Stroll-side tables are available in 3 heights with 2 different sizes, available with or without castors. These side tables provide yet another example of the mobility and flexibility of this series – the ideal companion beside a sofa, in the work room or as a useful extra surface in the kitchen.



Stroll is a series that encourages spontaneous meetings and – thanks to the ease with which the stools can be moved – flexible furnishing solutions.

Designer

Böttcher & Kayser is a Berlin-based studio founded in 2007, working in the fields of consumer product, furniture, lighting and interior design. Moritz Böttcher and Nikolaus Kayser have been rewarded with several prestigious awards such as the Interior Innovation Award, several iF Design Awards and numerous Red Dot Awards – including the award, Best of the Best' in 2013. Their projects have been published in books and magazines around the world.



Models



Stroll 46/XL



Stroll 46/XL with wheels



Stroll 80/XL



Stroll 65/XL



Stroll 65/XL with wheels



Stroll 65/XL with footrest



Stroll Bench 46



Stroll Bench 46, 2 wheels



Stroll Bench 46, 4 wheels



Stroll Bench 65



Stroll Bench 65, 2 wheels



Stroll Bench 65, 4 wheels

Models



Stroll Desk-72



Stroll Desk- 90



Stroll Table S-47



Stroll Table S-47 with wheels



Stroll Table L-47



Stroll Table L-47 with wheels



Stroll Table S-57



Stroll Table S-57 with wheels



Stroll Table L-57



Stroll Table L-57 with wheels



Stroll Table S-72



Stroll Table S-72 with wheels



Stroll Table L-72



Stroll Table L-72 with wheels

Models



Stroll Butler 53



Stroll Butler 73

Accessories



Wheels

Wheels black, white and chrome.



Wheels-Stroll Desk

Lockable wheels are available in black and white.

Material

Seat - Upholstery materials

Johanson offers a very generous range of fabrics, leather and artificial leather from the most reputable suppliers in the world. Should any other material be desired despite the wide selection, it is also possible to suggest other materials. Johanson does not charge start-up costs for handling non-standard materials.

Multicolour - Finish RAL

Take part in Johanson's color range, 405 variants of different finishes are offered as standard on steel frames and metal details. Choose from all 195 RAL colors, alternatives are available both as solid finish (gloss 72) or Structure finish which has a matte, slightly textured elegant surface. In addition, 15 RAL colors with pearl finish and chrome are offered.

For all colours see www.johansondesign.com

195 Solid collection (gloss 72)

195 Structure collection (matte, textured surface)

15 Pearl finish collection and chrome.



Table top



Stroll

Table top with rounded corners and straight edge in matching color, thickness 25mm of wood.



Laminat

White laminate

Forbo Desktop

4023 Nero

Forbo Desktop

4172 Mauve

Forbo Desktop

4132 Ash

Forbo Desktop

4179 Smokey Blue

Forbo Desktop

4174 Conifer

Forbo Desktop

4184 Olive

Forbo Desktop

4176 Mushroom

Facts

Stroll Family in detail

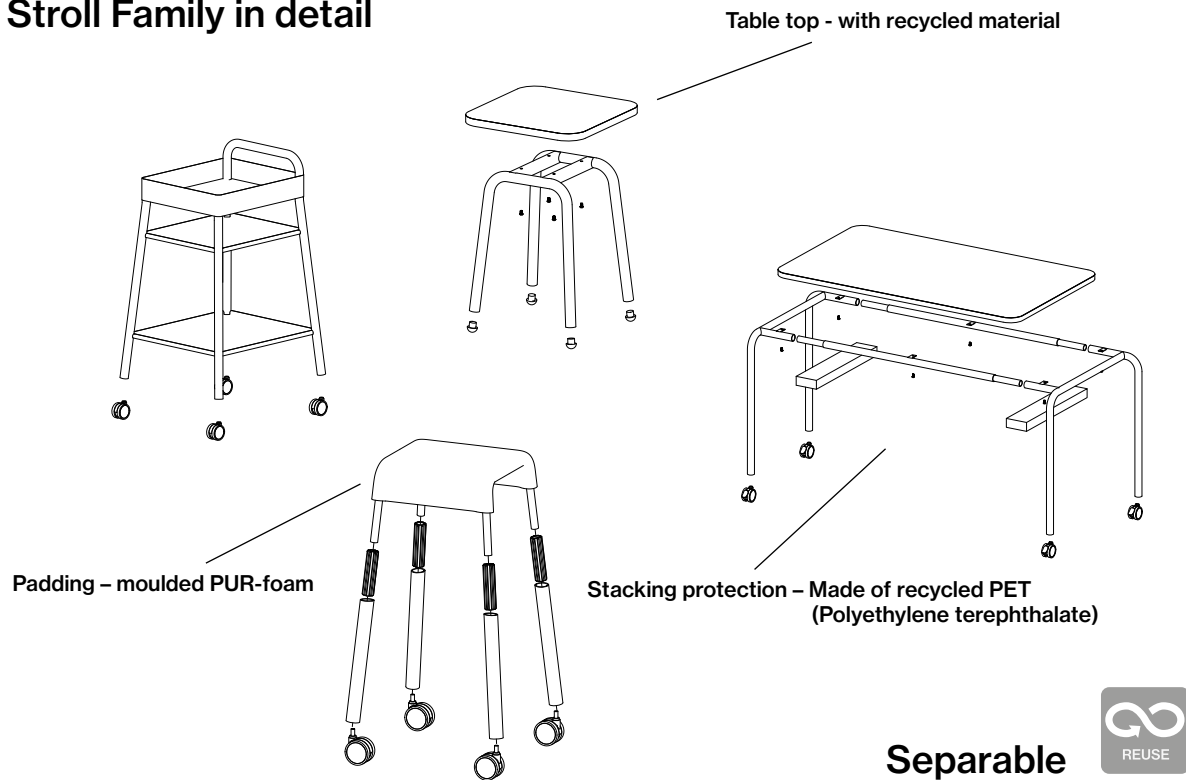

Material

Fully upholstered stool/barstool with moulded seat frame in polyether. Foam which meets the highest fire classification CMHR- Combustion Modified High Resilience, is available for all models on request. The base is made of finished/lacquered metal.

Recycling

All steel parts are recyclable. Before we finish the chrome/lacquer all grease/oil is removed by alkaline wash and then sent for destruction. The lacquering is produced by electrostatic epoxy powder coating that gives a minimum of waste. The electrostatic chrome (chrome 3) is recyclable. The plastic parts that are used are recyclable by grinding. All upholstery and frames of synthetic material are totally without C.F.C. emissions. All glue is water based.

Certificate

- Fire certificate (Danak)



BIM - objects can be downloaded

at johansondesign.com

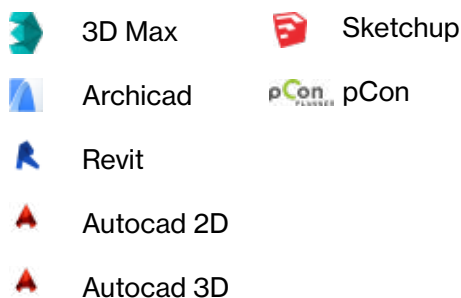

Facts

Stroll 46/65/80

Measurements cm

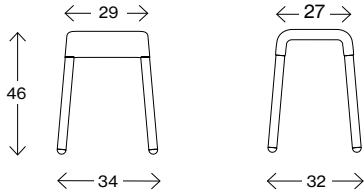

Stroll 46

Weight (kg) 3,7
Volume (m³) 0,052



Measurements cm

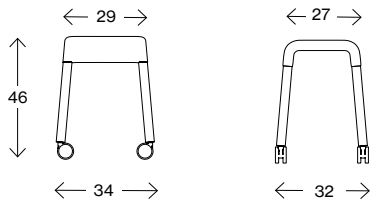

Stroll 46 with wheels

Weight (kg) 4,0
Volume (m³) 0,053



Measurements cm

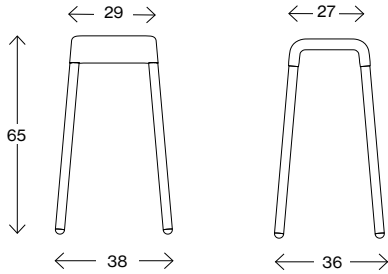

Stroll 65

Weight (kg) 5,3
Volume (m³) 0,091



Measurements cm

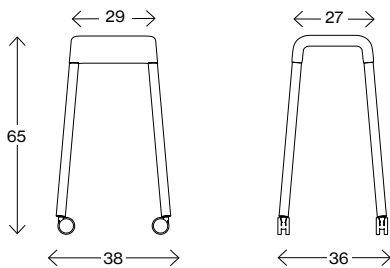

Stroll 65 with wheels

Weight (kg) 5,6
Volume (m³) 0,091



Measurements cm

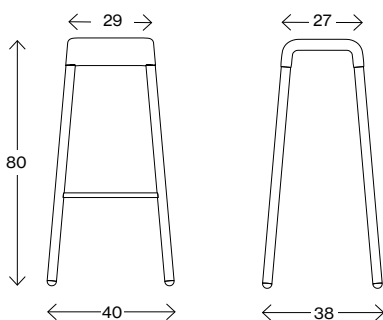

Stroll 80

Weight (kg) 6,5
Volume (m³) 0,130

Facts

Stroll XL 46/65/80

Measurements cm

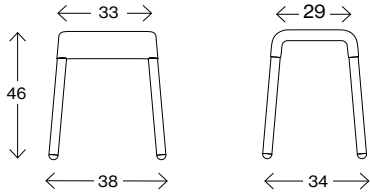

Stroll XL 46



Weight (kg) -
Volume (m³) 0,06

Measurements cm

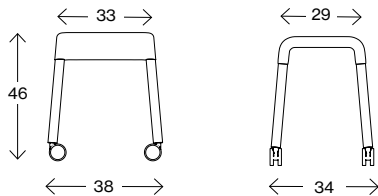

Stroll XL 46 with wheels



Weight (kg) -
Volume (m³) 0,06

Measurements cm

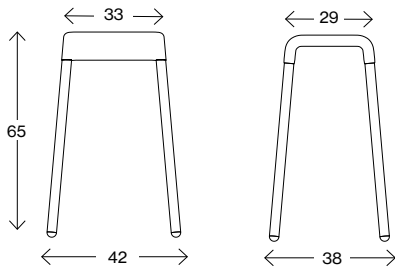

Stroll XL 65



Fabric requirement (r.m) 0,6
Leather requirement (m²) 1,1
Weight (kg) -
Volume (m³) 0,14

Measurements cm

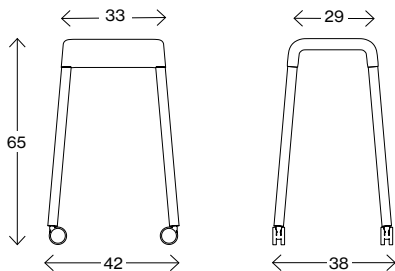

Stroll XL 65 with wheels



Weight (kg) -
Volume (m³) 0,14

Measurements cm

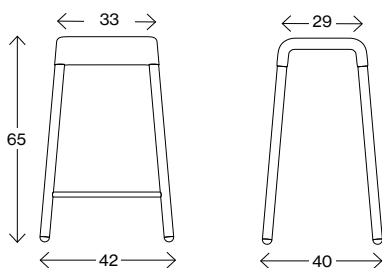

Stroll XL 65 with footrest

1
Weight (kg) -
Volume (m³) 0,14

Facts

Stroll XL 46/65/80

Measurements cm

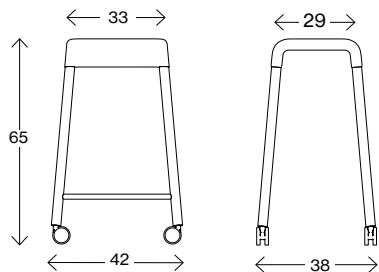

Stroll XL 65 with footrest and wheels

Weight (kg) -
Volume (m³) 0,14

Measurements cm

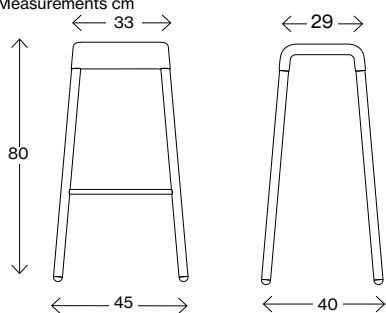

Stroll XL 80

Weight (kg) -
Volume (m³) 0,14

Facts

Stroll Bench 46

Measurements cm

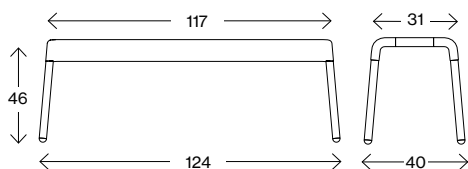

Stroll Bench 46



Fabric requirement (r.m)	1,3
Leather requirement (m ²)	2,8
Weight (kg)	8,6
Volume (m ³)	0,228

Measurements cm

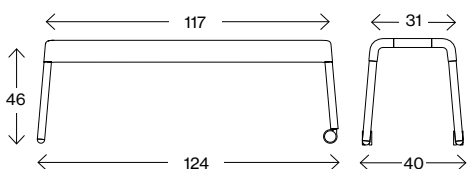

Stroll Bench 46, 2 wheels



Fabric requirement (r.m)	1,3
Leather requirement (m ²)	2,8
Weight (kg)	8,7
Volume (m ³)	0,228

Measurements cm

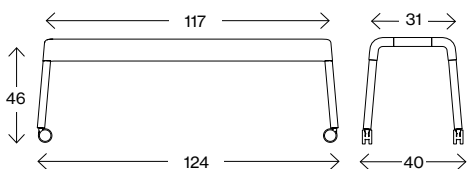

Stroll Bench 46, 4 wheels



Fabric requirement (r.m)	1,3
Leather requirement (m ²)	2,8
Weight (kg)	8,9
Volume (m ³)	0,228

Facts

Stroll Bench 65

Measurements cm

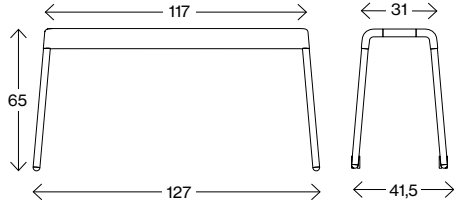

Stroll Bench 65

Fabric requirement (r.m)	1,3
Leather requirement (m ²)	2,8
Weight (kg)	9,9
Volume (m ³)	0,322



Measurements cm

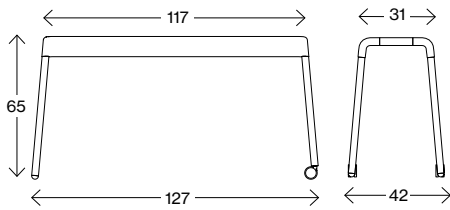

Stroll Bench 65, 2 wheels

Fabric requirement (r.m)	1,3
Leather requirement (m ²)	2,8
Weight (kg)	10,0
Volume (m ³)	0,322



Measurements cm

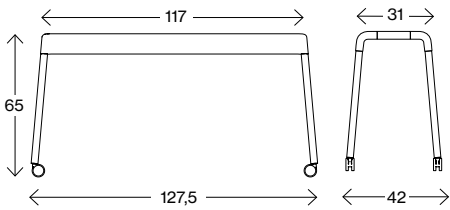

Stroll Bench 65, 4 wheels

Fabric requirement (r.m)	1,3
Leather requirement (m ²)	2,8
Weight (kg)	10,2
Volume (m ³)	0,322



Facts

Stroll Desk-72

Measurements cm

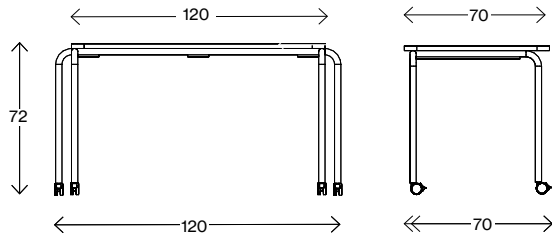

Stroll Desk 72-70x120

Weight (kg)	23,5
Volume (m ³)	0,69
Stackability	4
Lockable wheels	

Measurements cm

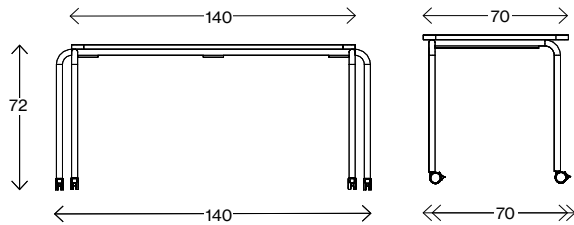

Stroll Desk 72-70x140

Weight (kg)	26,3
Volume (m ³)	0,719
Stackability	4
Lockable wheels	

Measurements cm

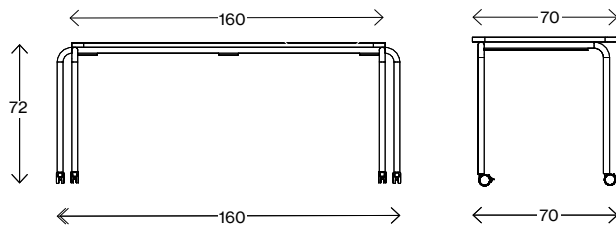

Stroll Desk 72-70x160

Weight (kg)	29,1
Volume (m ³)	0,89
Stackability	4
Lockable wheels	



Stackability < 4

Facts

Stroll Desk -90

Measurements cm

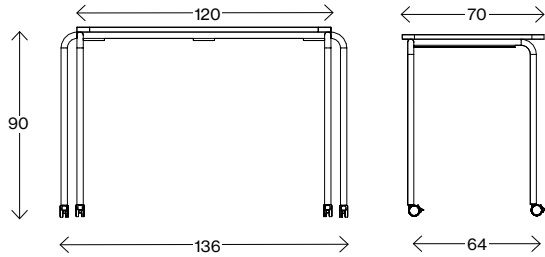

Stroll Desk 90-70x120

Weight (kg)	24,3
Volume (m ³)	0,86
Stackability	4
Lockable wheels	

Measurements cm

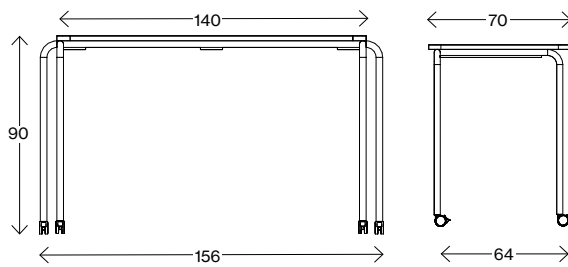

Stroll Desk 90-70x140

Weight (kg)	27,1
Volume (m ³)	0,98
Stackability	4
Lockable wheels	

Measurements cm

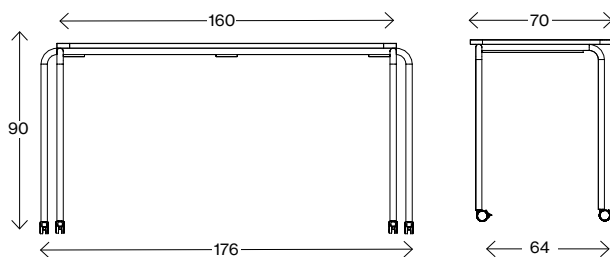

Stroll Desk 90-70x160

Weight (kg)	29,9
Volume (m ³)	1,11
Stackability	4
Lockable wheels	



Stackability < 4

Facts

Stroll Table

Measurements cm

Stroll Table S-47 40x40

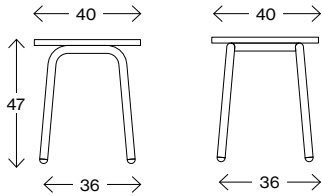

Weight (kg) 6,4
Volume (m³) 0,08

Measurements cm

Stroll Table S-47 40x40, wheels

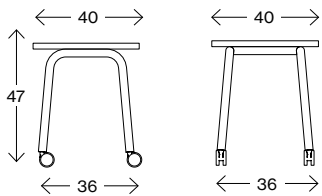

Weight (kg) 6,4
Volume (m³) 0,08

Measurements cm

Stroll Table L-47 60x60

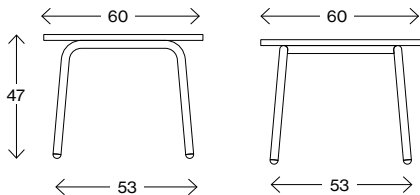

Weight (kg) 11,6
Volume (m³) 0,17

Measurements cm

Stroll Table L-47 60x60, wheels

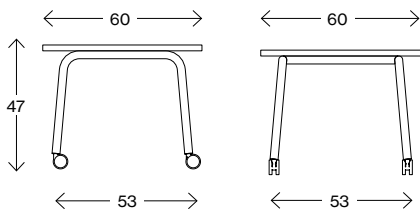

Weight (kg) 11,6
Volume (m³) 0,17

Measurements cm

Stroll Table S-57 40x40

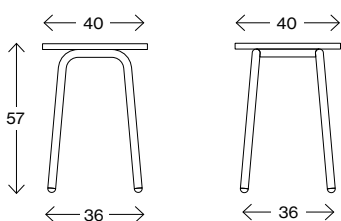

Weight (kg) 7,0
Volume (m³) 0,09

Facts

Stroll Table

Measurements cm

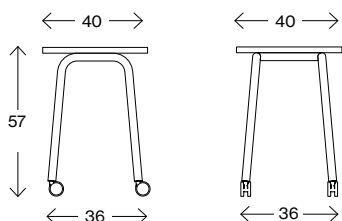

Stroll Table S-57 40x40, wheels

Weight (kg) 7,0
Volume (m³) 0,09

Measurements cm

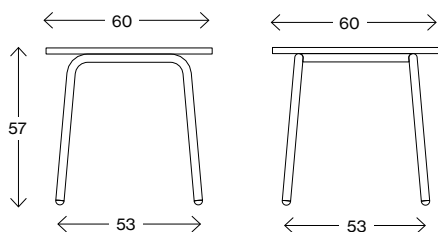

Stroll Table L-57 60x60

Weight (kg) 11,8
Volume (m³) 0,211

Measurements cm

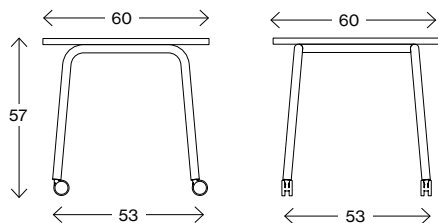

Stroll Table L-57 60x60, wheels

Weight (kg) 11,8
Volume (m³) 0,211

Measurements cm

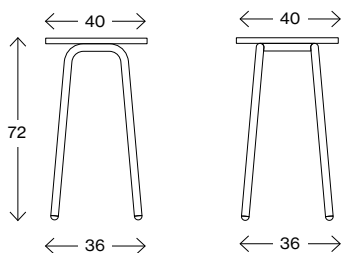

Stroll Table S-72 40x40

Weight (kg) 7,6
Volume (m³) 0,12

Measurements cm

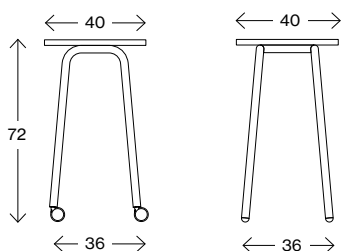

Stroll Table S-72 40x40, wheels

Weight (kg) 7,6
Volume (m³) 0,12

Facts

Stroll Table

Measurements cm

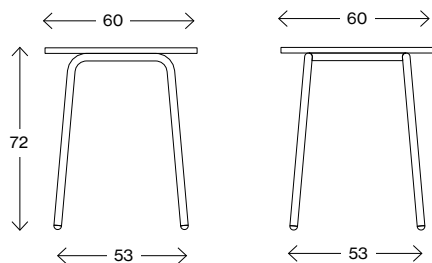

Stroll Table L-72 60x60

Weight (kg) 12,2
Volume (m³) 0,26

Measurements cm

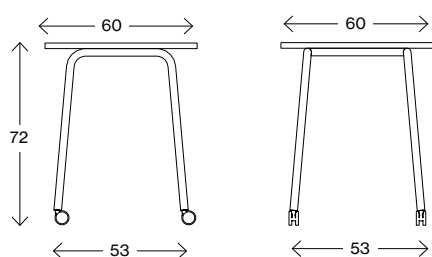

Stroll Table L-72 60x60, wheels

Weight (kg) 12,2
Volume (m³) 0,26

Stroll Butler

Measurements cm

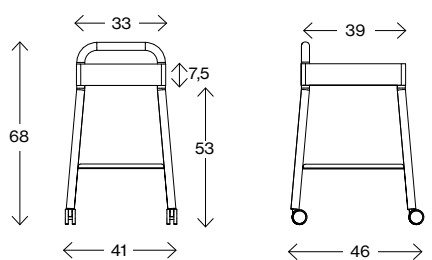

Stroll Butler 53

Weight (kg) 8,8
Volume (m³) 0,128

Measurements cm

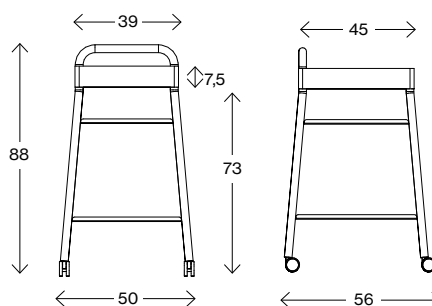

Stroll Butler 73

Weight (kg) 14,0
Volume (m³) 0,246













JOHANSON

Johanson Design AB | Anders Anderssons Väg 7 | 285 35 Markaryd | Sweden
Tel +46-433 725 00 | www.johansondesign.com