

Family  
**Atticus**

Design – Erin Ruby

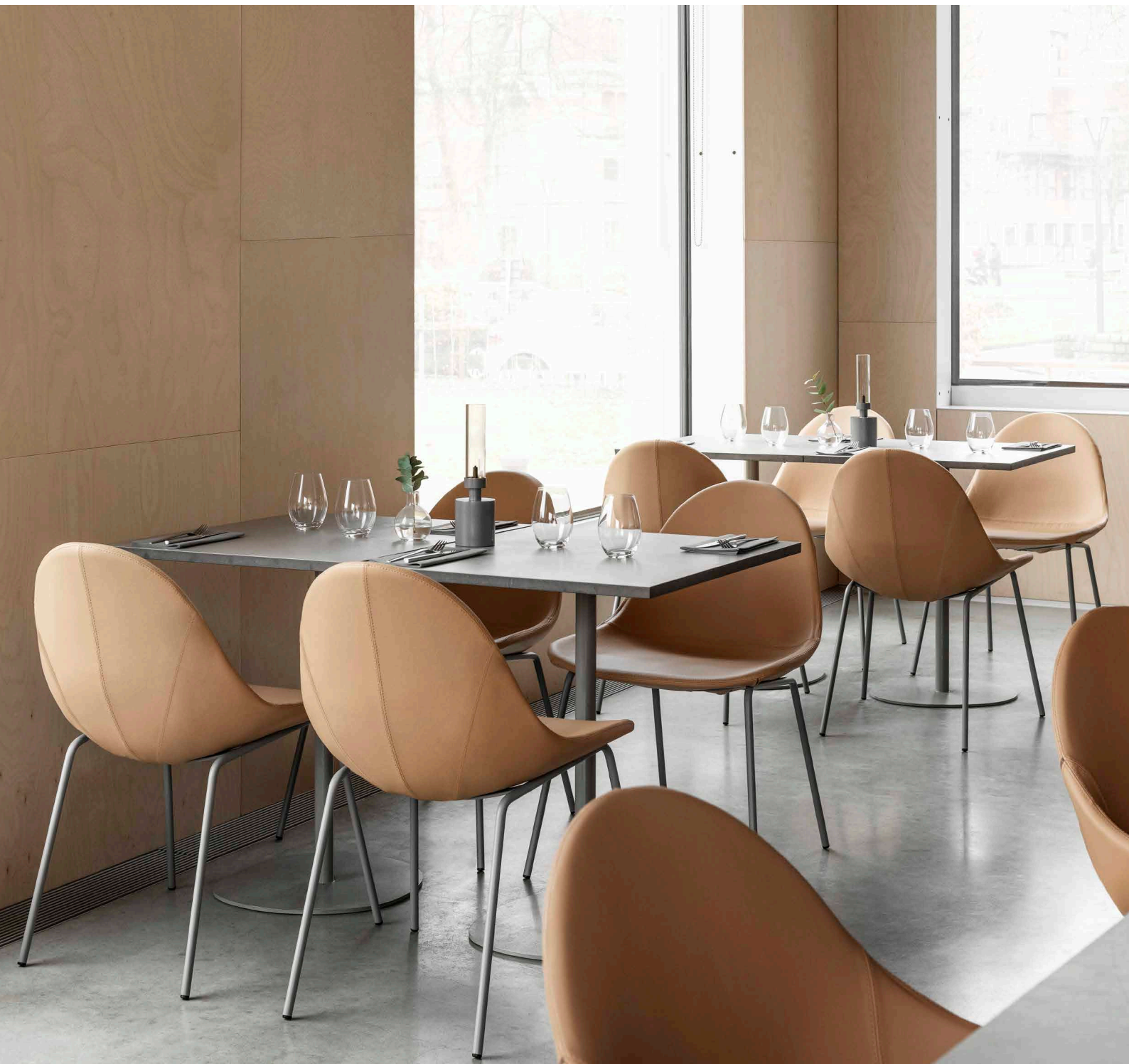

**JOHANSON**



## Introduction

Atticus takes its inspiration from Harper Lee's "To Kill A Mockingbird". The Atticus concept has its roots in the natural world, most specifically the North American mockingbird with its elegantly rounded wings that assume an almost shell-like form.

The chairs are comfortable and inviting, with armrests that subtly embrace the user. The easy chair is available in low-back and high-back versions, allowing the user to produce the sensation of a relaxed lounge-style setting or to offer comfortable seating in the conference room.

The series is suitable for use in both small and larger settings, and the chairs blend in well in a wide variety

of environments. With its numerous variations on a basic theme, Atticus is a flexible, all-round solution – not only for individual offices and conference rooms, but also for cafés and domestic living rooms.

Atticus takes its name from the iconic hero of Harper Lee's classic American novel from 1960, To Kill A Mockingbird. Erin says: "It's not only one of my favourite books; its enduring story of justice for the underdog is especially relevant today. With this in mind, I sought to bridge my American heritage with Johanson's Swedish roots to create a new icon for the company. Atticus is a timeless collection based on respect for form, craftsmanship, comfort, and elegance."



## Designer

Based in New York City, Erin Ruby is an American designer of interiors and products, known for her holistic approach to design. Her philosophy is rooted in designing for the human experience; always considering how we interact and respond to the objects in our everyday life, which ultimately informs her products. The chairs in the Atticus collection have an organic shape, inspired by nature and intended for comfort.





# Models

---



Atticus - armless 03-46



Atticus -with arms 03-46



Atticus-armless-03-46 with wheels\*



Atticus-with arms-03-46 with wheels\*



Atticus - armless 08-46



Atticus -with arms 08-46



Atticus-armless-08-46 Wood



Atticus- with arms-08-46 Wood



Atticus - armless 09-46



Atticus -with arms 09-46

\* Available with tilt mechanism and height adjustment

# Models

---



**Atticus-BS armless 08-64**



**Atticus-BS armless 08-77**



**Atticus-BS with arms 08-64**



**Atticus-BS with arms 08-77**



**Atticus-BS armless 09-64**



**Atticus-BS armless 09-77**



**Atticus-BS with arms 09-64**



**Atticus-BS with arms 09-77**

# Models

---



Atticus - Lounge Low 03



Atticus - Lounge High 03



Atticus - Lounge Low 08 Wood



Atticus - Lounge High 08 Wood



Atticus - Lounge Low 09



Atticus - Lounge High 09

# Material

---



Legs 08



Oak



White stained oak



Black stained oak

## Seat - Upholstery materials

Johanson offers a very generous range of fabrics, leather and artificial leather from the most reputable suppliers in the world. Should any other material be desired despite the wide selection, it is also possible to suggest other materials. Johanson does not charge start-up costs for handling non-standard materials.

## Multicolour - Finish RAL

Take part in Johanson's color range, 405 variants of different finishes are offered as standard on steel frames and metal details. Choose from all 195 RAL colors, alternatives are available both as solid finish (gloss 72) or Structure finish which has a matte, slightly textured elegant surface. In addition, 15 RAL colors with pearl finish and chrome or polished aluminum are offered.

For all colours see [www.johansondesign.com](http://www.johansondesign.com)

**195 Solid collection (gloss 72)**

**195 Structure collection (matte, textured surface)**

**15 Pearl finish collection**

**Chrome (08, 09- base)**

**Polished aluminum (03-base).**



# Accessories

---

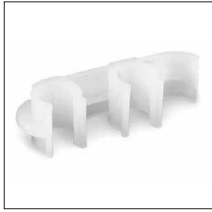

## Connector

08-base



## Wheels

Wheels for 03-base in black, white and chrome.



## Connector

09-base

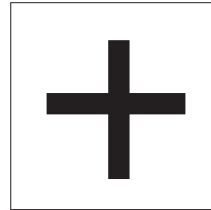

## Extra

Felt gliders

# Facts

---

## Material

Fully upholstered armchair with moulded seat frame in polyether. Foam which meets the highest fire classification CMHR- Combustion Modified High Resilience, is available for all models on request. The base is made of finished/lacquered metal.

## Certificate

- Fire certificate (Danak)



## Recycling

All steel parts are recyclable. Before we finish the chrome/lacquer all grease/oil is removed by alkaline wash and then sent for destruction. The lacquering is produced by electrostatic epoxy powder coating that gives a minimum of waste. The electrostatic chrome (chrome 3) is recyclable. The plastic parts that are used are recyclable by grinding. All upholstery and frames of synthetic material are totally without C.F.C. emissions. All glue is water based.

**BIM - objects can be downloaded**

at [johansondesign.com](http://johansondesign.com)

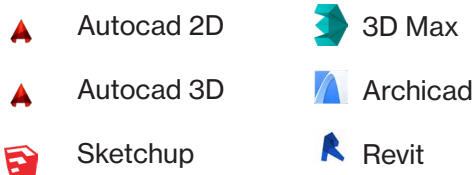

 pCon



Measurements cm

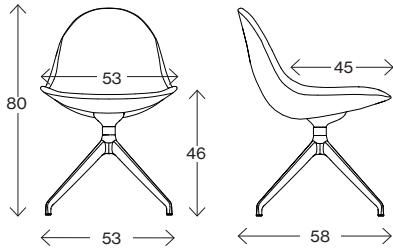

### Atticus - armless 03-46

Weight (kg)	8,0
Volume (m <sup>3</sup> )	0,34
Height with height adjustment	77 - 88
Seat height with height adjustment	42 - 53

Swivel base

Measurements cm

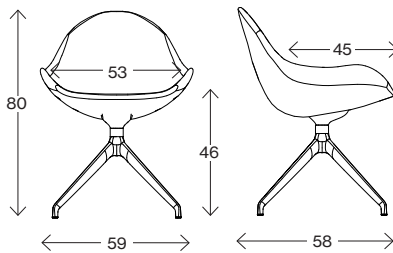

### Atticus - with arms 03-46

Weight (kg)	8,0
Volume (m <sup>3</sup> )	0,34
Height with height adjustment	77 - 88
Seat height with height adjustment	42 - 53

Swivel base

Measurements cm

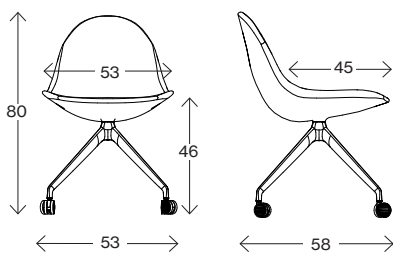

### Atticus-armless-03-46 with wheels

Weight (kg)	8,0
Volume (m <sup>3</sup> )	0,34
Height with height adjustment	77 - 88
Seat height with height adjustment	42 - 53

Swivel base

Measurements cm

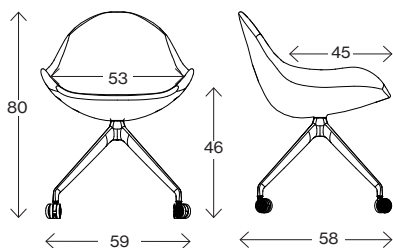

### Atticus - with arms 03-46 with wheels

Weight (kg)	8,0
Volume (m <sup>3</sup> )	0,34
Height with height adjustment	77 - 88
Seat height with height adjustment	42 - 53

Swivel base

# Facts

## Atticus

Measurements cm

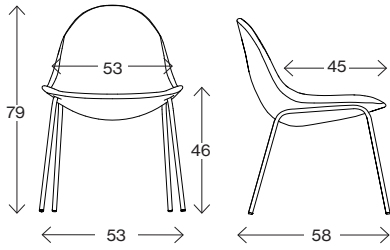

### Atticus - armless 08-46

Weight (kg) 7,0  
Volume (m<sup>3</sup>) 0,34

Measurements cm

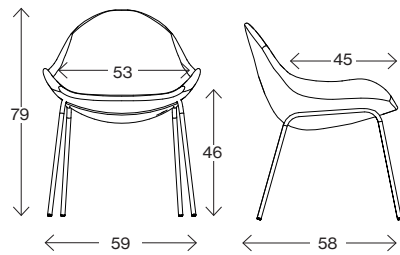

### Atticus - with arms 08-46

Weight (kg) 7,0  
Volume (m<sup>3</sup>) 0,34

Measurements cm

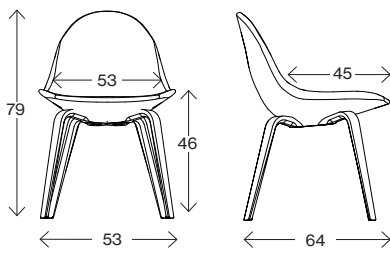

### Atticus-armless-08-46 wood

Weight (kg) 8,0  
Volume (m<sup>3</sup>) 0,34

Measurements cm

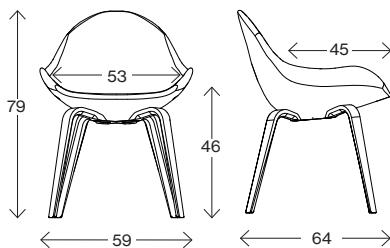

### Atticus - with arms 08-46 wood

Weight (kg) 8,0  
Volume (m<sup>3</sup>) 0,34

# Facts

## Atticus

Measurements cm

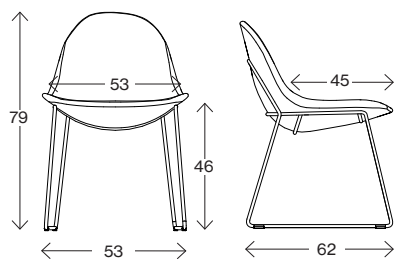

### Atticus - armless 09-46

Weight (kg) 10,0  
Volume (m<sup>3</sup>) 0,34

Measurements cm

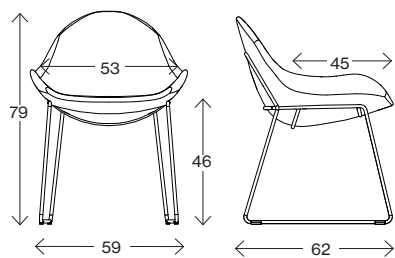

### Atticus - with arms 09-46

Weight (kg) 10,0  
Volume (m<sup>3</sup>) 0,34

# Facts

## Atticus-BS

Measurements cm

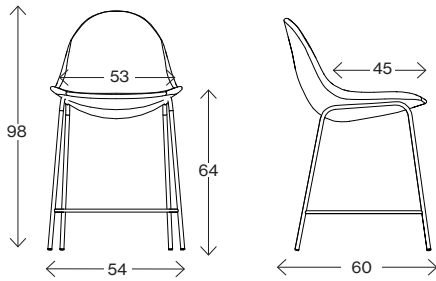

### Atticus-BS-armless-08-64

Weight (kg) 10,0  
Volume (m<sup>3</sup>) 0,45

Measurements cm

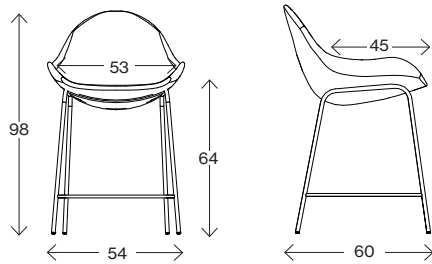

### Atticus-BS-with arms-08-64

Weight (kg) 10,0  
Volume (m<sup>3</sup>) 0,45

Measurements cm

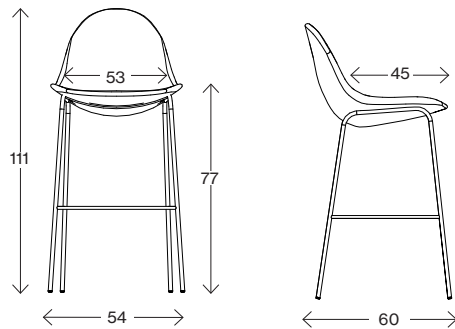

### Atticus-BS-armless-08-77

Weight (kg) 10,0  
Volume (m<sup>3</sup>) 0,51

Measurements cm

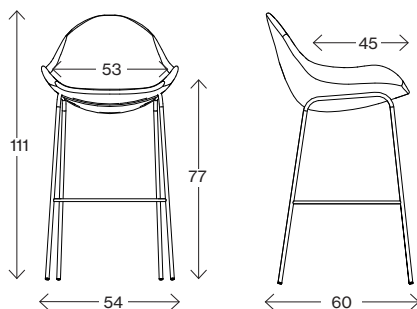

### Atticus-BS-with arms-08-77

Weight (kg) 10,0  
Volume (m<sup>3</sup>) 0,51

# Facts

## Atticus-BS

Measurements cm

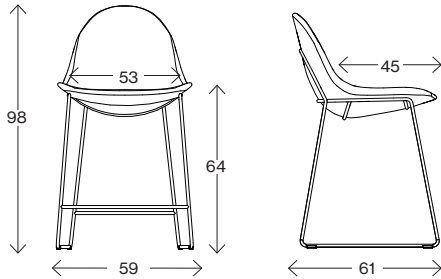

### Atticus-BS-armless-09-64

Weight (kg) 10,0  
Volume (m<sup>3</sup>) 0,45

Measurements cm

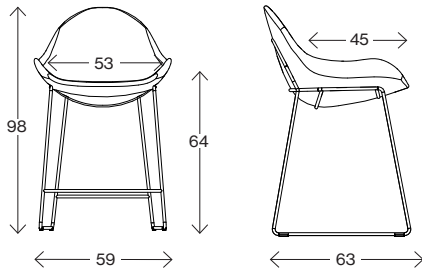

### Atticus-BS-with arms-09-64

Weight (kg) 10,0  
Volume (m<sup>3</sup>) 0,45

Measurements cm

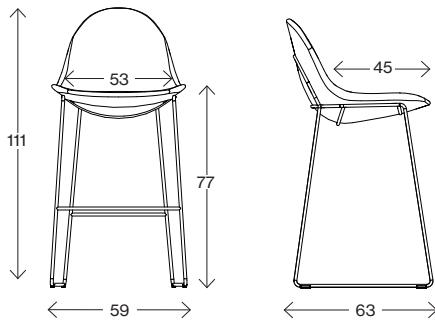

### Atticus-BS armless- 09-77

Weight (kg) 10,0  
Volume (m<sup>3</sup>) 0,51

Measurements cm

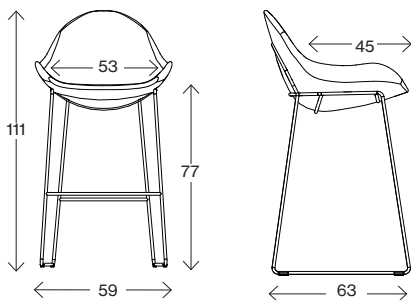

### Atticus-BS-with arms-09-77

Weight (kg) 10,0  
Volume (m<sup>3</sup>) 0,51



# Facts

## Atticus-Lounge

Measurements cm

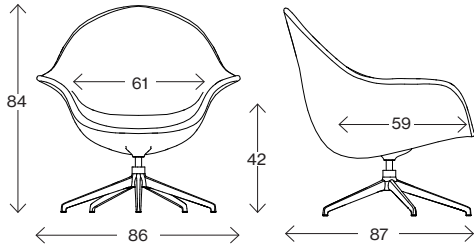

### Atticus - Lounge Low 03

Weight (kg) 14,0  
Volume (m<sup>3</sup>) 0,85

Measurements cm

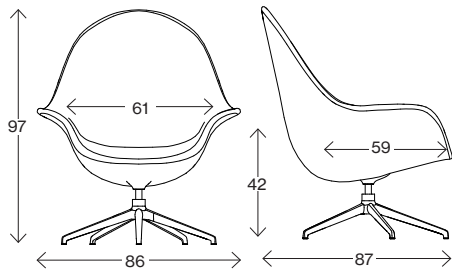

### Atticus - Lounge High 03

Weight (kg) 14,0  
Volume (m<sup>3</sup>) 0,85

Measurements cm

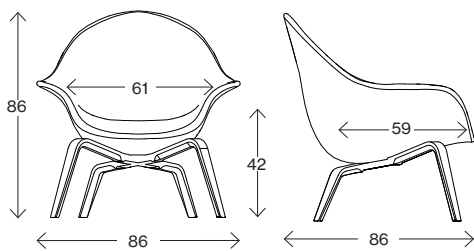

### Atticus - Lounge Low 08 Wood

Weight (kg) 13,0  
Volume (m<sup>3</sup>) 0,85

Measurements cm

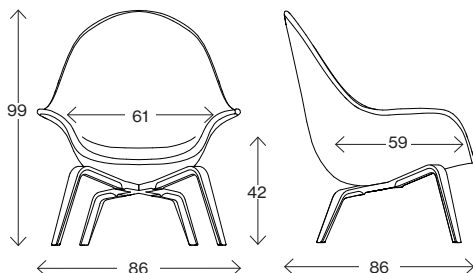

### Atticus - Lounge High 08 Wood

Weight (kg) 13,0  
Volume (m<sup>3</sup>) 0,85

# Facts

## Atticus-Lounge

Measurements cm

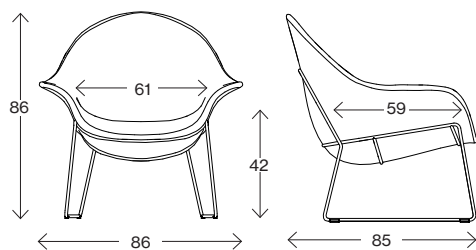

### Atticus - Lounge Low 09

Weight (kg) 17,0  
Volume (m<sup>3</sup>) 0,85

Measurements cm

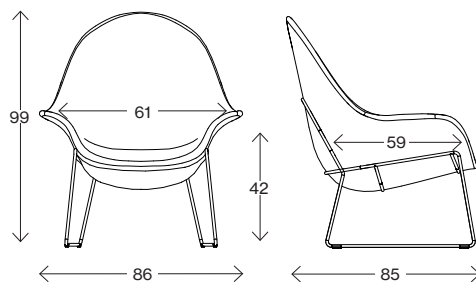

### Atticus - Lounge High 09

Weight (kg) 17,0  
Volume (m<sup>3</sup>) 0,85















# JOHANSON

---

Johanson Design AB | Anders Anderssons Väg 7 | 285 35 Markaryd | Sweden  
Tel +46-433 725 00 | [www.johansondesign.com](http://www.johansondesign.com)