

# Bail

Design – Böttcher & Kayser



**JOHANSON**



## Introduction

Bail is a flexible, versatile series with plenty of potential for variation. It is easily combined and blends in well in many different types of settings – from hotels, lobbies and waiting rooms to lounge areas and offices. The elegantly pared-down design also ensures that Bail is equally at home in private domestic environments. The flexibility of the Bail bench system is further enhanced by its accessories, making it ideal not only for furnishing solutions for informal meetings and creative encounters, but

also for more secluded areas that serve as quiet zones with fewer distractions for tasks that demand greater concentration. Bail enables you to create rooms within a room and furnish spaces to meet your specific needs.

The Bail series also includes accessories such as tables and planters. You can use these to further emphasise the “room within a room” sensation and create an entire furnishing solution totally adapted to your needs and wishes in terms of function and colour.

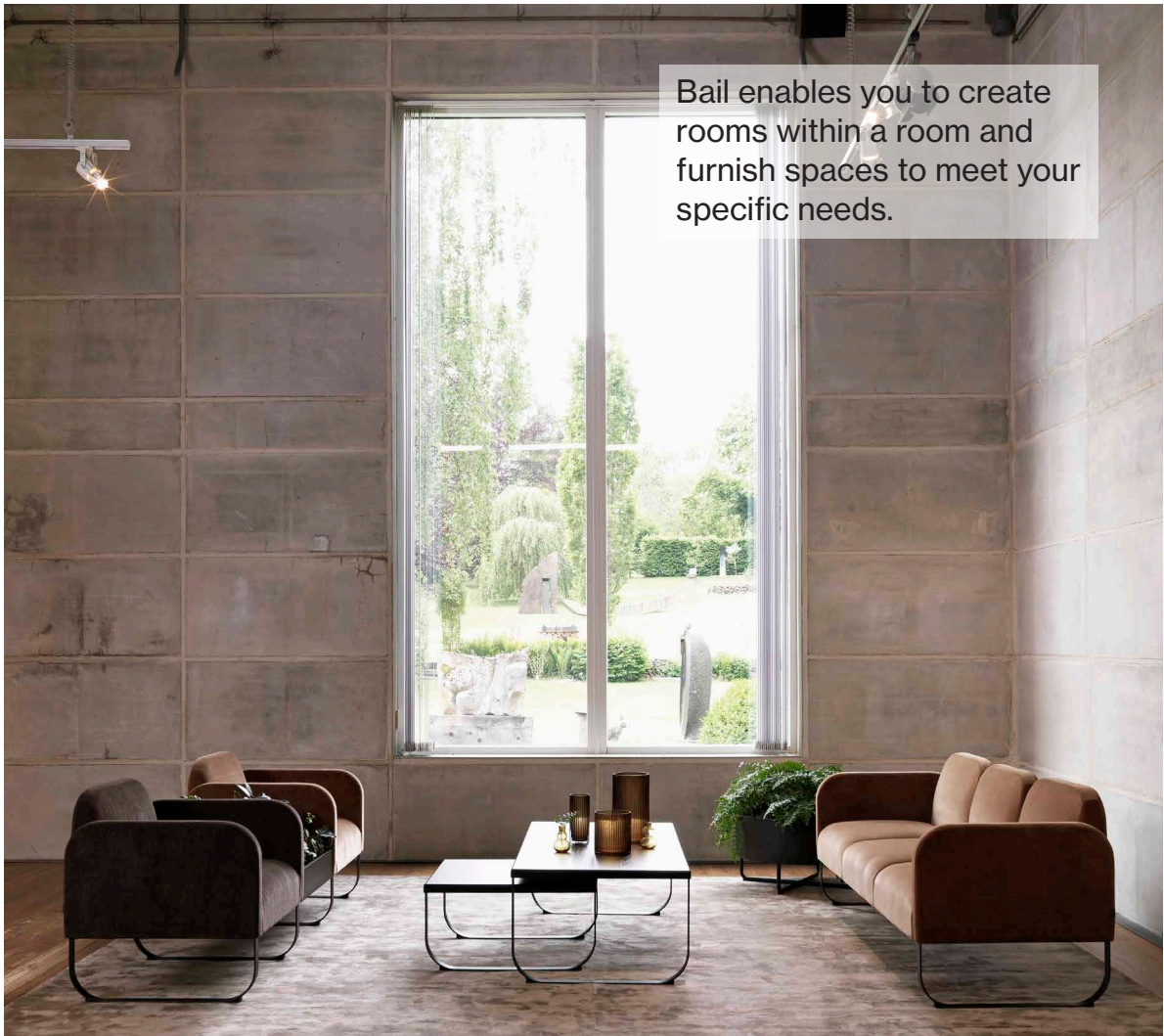

## Designer

Böttcher & Kayser is a Berlin-based studio founded in 2007, working in the fields of consumer product, furniture, lighting and interior design. Moritz Böttcher and Nikolaus Kayser have been rewarded with several prestigious awards such as the Interior Innovation Award, several iF Design Awards and numerous Red Dot Awards – including the award, 'Best of the Best' in 2013. Their projects have been published in books and magazines around the world.



# Models

---



1-seater bench



2-seater bench



3-seater bench



1-seater



2-seater



3-seater



1-seater with armrests



2-seater with armrests



3-seater with armrests



1-seater with screen back and screen sides



2-sits, screen back, screen side



3-sits, screen back, screen side



Bail Corner 45°



Bail Corner 90°, round



Bail Corner 90°, straight

# Models

---



Bail Garden 61x66



Bail Table 61x66



Bail Table 132x66



Bail Coffe Table Ø28

# Examples of combinations

---



2-seater with two armrests and Bail Table 61x66 oak veneer



2-seater with two armrests and Bail Garden 61x66



4-seater with two armrests and Bail Table 61x66 oak veneer



5-seater with two armrests and one Bail Corner 45°



6-seater with two armrests and two Bail Corner 45°



5-seater with two armrests and one Bail corner 90°

# Material

---

## Seat - Upholstery materials

Johanson offers a very generous range of fabrics, leather and artificial leather from the most reputable suppliers in the world. Should any other material be desired despite the wide selection, it is also possible to suggest other materials. Johanson does not charge start-up costs for handling non-standard materials.

## Multicolour - Finish RAL

Take part in Johanson's color range, 405 variants of different finishes are offered as standard on steel frames and metal details. Choose from all 195 RAL colors, alternatives are available both as solid finish (gloss 72) or Structure finish which has a matte, slightly textured elegant surface. In addition, 15 RAL colors with pearl finish and chrome are offered.

For all colours see [www.johansondesign.com](http://www.johansondesign.com)

**195 Solid collection (gloss 72)**

**195 Structure collection (matte, textured surface)**

**15 Pearl finish collection and chrome.**

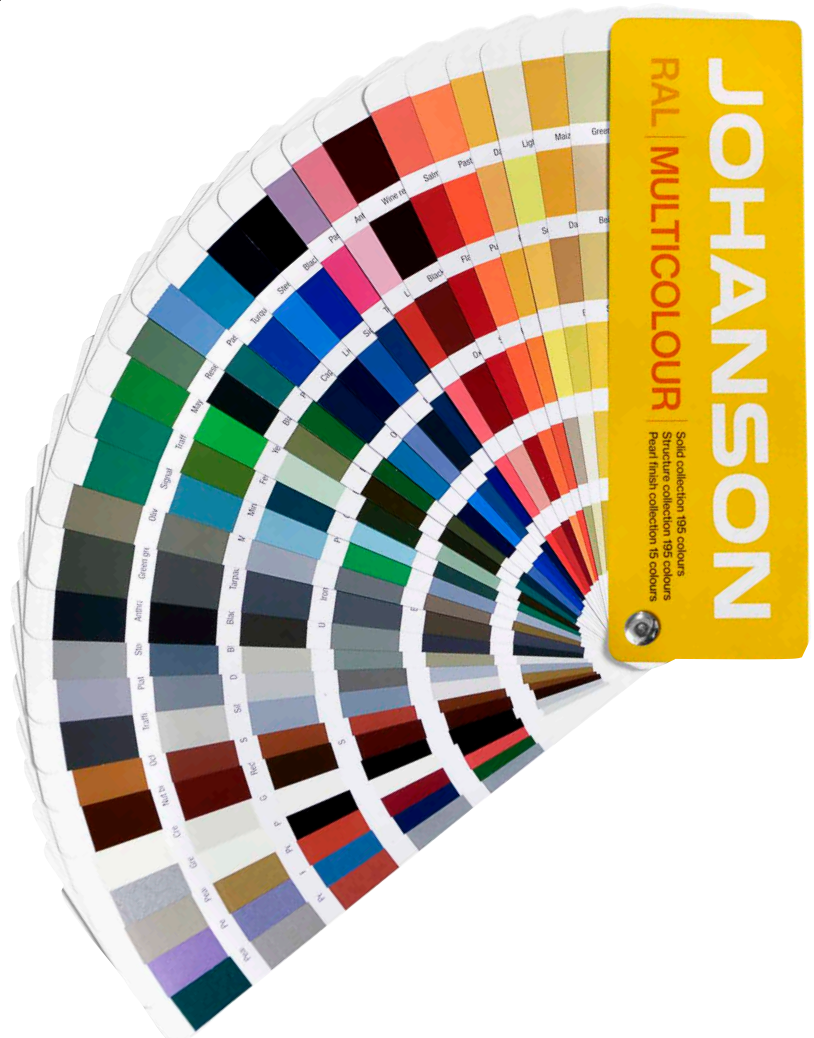

# Accessories

---

## Electrical equipment

Thanks to the bracket, you can mount a Powerdot Mini with power socket or smart charging with 2 USB-C sockets in the desired location using the included screws.



## Bracket



**Powerdot bracket mini, single**  
Black / white



**Powerdot bracket mini, double**  
Black / white

## Powerdot



**Powerdot Mini Electric**  
1 power (type F, Schuko)  
Black / white



**Powerdot Mini USB**  
2 USB-C PD  
(30W/20V/1,5A)  
Black / white



**Buttons**  
Ø18mm, Ø30mm,  
Ø50mm



**Connector**

# Table top



## Bail Coffe Table

Ø28

### Finish

White laminate  
Black laminate  
Light grey laminate  
Oak laminate  
Birch laminate  
Wenge laminate  
Walnut laminate  
Ash laminate  
Oak veneer  
Birch veneer  
Ash veneer  
Formica Collection Colors  
White laminate  
Black laminate  
Black stained oak veneer  
White stained oak veneer  
Black stained ash veneer  
White stained ash veneer  
Abet Laminati  
Abet Laminati  
Abet Laminati  
Fenix NTM laminate  
Fenix NTM laminate  
Fenix NTM laminate  
Fenix NTM laminate  
Formica Collection True Scale  
Formica Collection True Scale  
Formica Collection True Scale  
Formica Collection Patterns  
Formica Collection Colors

### Description

F1040 MAT Alpino RAL 9010  
F2253 MAT Diamond black RAL 9011  
F7927 MAT Folkestone NCS S 2500-N  
F5374 NAT Elegant oak  
F7921 MAT Birch  
F1614 MAT Punga Punga Wood  
F5150 MAT American Walnut  
F8843 NAT Natural Ash  
Clear lacquered oak veneer  
Clear lacquered birch veneer  
Clear lacquered ash veneer  
Any color from Formica Collection Colors:  
F1040 MAT Alpino RAL 9010  
F2253 MAT Diamond black RAL 9011  
Black stained lacquered oak veneer  
Oak veneer white pigmented hardwax  
Black stained lacquered ash veneer  
Ash veneer white pigmented hardwax  
Rocks 557 Papier  
Rocks 1451 Papier  
Rocks 596 Climb  
0718 Grigio Londra  
0720 Nero Ingo  
0724 Grigio Bromo  
0752 Grigio Antrim  
F3458 Travertine Silver AR Plus  
F3457 Breccia Paradiso AR Plus  
F3476 Jet Sequoia AR Plus  
F8832 Elemental Corten AHD  
Any color from Formica Collection Colors:

### Edge

Discus edge, natural lacq. MDF  
Discus edge, natural lacq. MDF  
Discus edge, natural lacq. MDF  
Discus edge, natural lacq. MDF  
Discus edge, natural lacq. MDF  
Discus edge, natural lacq. MDF  
Discus edge, natural lacq. MDF  
Discus edge, natural lacq. MDF  
Discus edge, natural lacq. MDF  
Discus edge, natural lacq. MDF  
Discus edge, natural lacq. MDF  
Discus edge, white lacquered MDF  
Discus edge, black MDF  
Discus edge, black stained MDF  
Discus edge, white stained MDF  
Discus edge, black stained MDF  
Discus edge, white stained MDF  
Discus edge, natural lacq. MDF  
Discus edge, natural lacq. MDF  
Discus edge, natural lacq. MDF  
Discus edge, black MDF  
Discus edge, black MDF  
Discus edge, black MDF  
Discus edge, black MDF  
Discus edge, natural lacq. MDF  
Discus edge, natural lacq. MDF  
Discus edge, natural lacq. MDF  
Discus edge, natural lacq. MDF  
Discus edge, natural lacq. MDF  
Discus edge, natural lacq. MDF  
Colour lacquered to match laminate



## Bail Table

61x66, 132x66

### Finish

Oak veneer  
Birch veneer  
Ash veneer  
Black stained oak veneer  
White stained oak veneer  
Black stained ash veneer  
White stained ash veneer

### Description

Clear lacquered oak veneer  
Clear lacquered birch veneer  
Clear lacquered ash veneer  
Black stained lacquered oak veneer  
Oak veneer white pigmented hardwax  
Black stained lacquered ash veneer  
Ash veneer white pigmented hardwax



# Facts

---

## Material

The seat is made of wood and polyether. Foam which meets the highest fire classification CMHR- Combustion Modified High Resilience, is available for all models on request. The base is made of finished/lacquerd metal.

## Certificate

- Fire certificate (Danak)



## Recycling

All steel parts are recyclable. Before we finish the chrome/lacquer all grease/oil is removed by alkaline wash and then sent for destruction. The lacquering is produced by electrostatic epoxy powder coating that gives a minimum of waste. The electrostatic chrome (chrome 3) is recyclable. The plastic parts that are used are recyclable by grinding. All upholstery and frames of synthetic material are totally without C.F.C. emissions. All glue is water based.

## BIM - objects can be downloaded

at [johansondesign.com](http://johansondesign.com)



3D Max



Archicad



Revit



Autocad 2D



Autocad 3D



Sketchup

 pCon  
PLANNER

# Facts

## Bail

Measurements cm

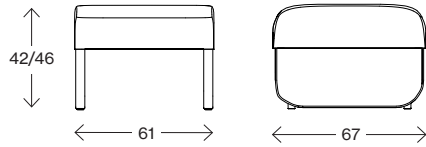

**1-seater bench**

Weight (kg)

17,3

Measurements cm

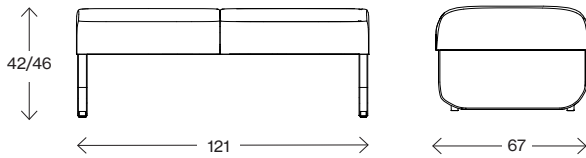

**2-seater bench**

Weight (kg)

27,4

Measurements cm

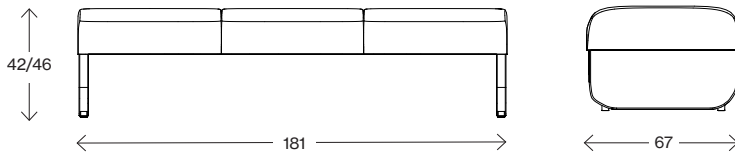

**3-seater bench**

Weight (kg)

37,5

Measurements cm

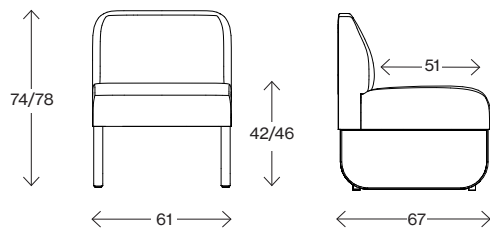

**1-seater**

Weight (kg)

21,1

Measurements cm

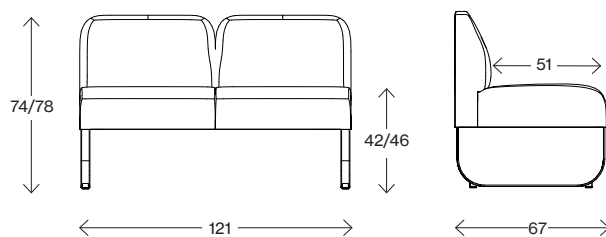

**2-seater**

Weight (kg)

35,0

# Facts

## Bail

Measurements cm

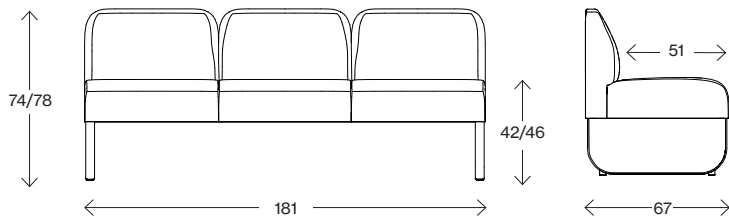

**3-seater**

Weight (kg) 48,6

Measurements cm

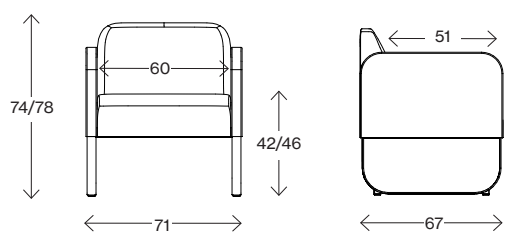

**1-seater with armrests**

Weight (kg) 28,6

Measurements cm

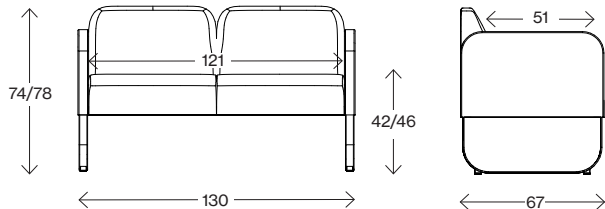

**2-seater with armrests**

Weight (kg) 42,3

Measurements cm

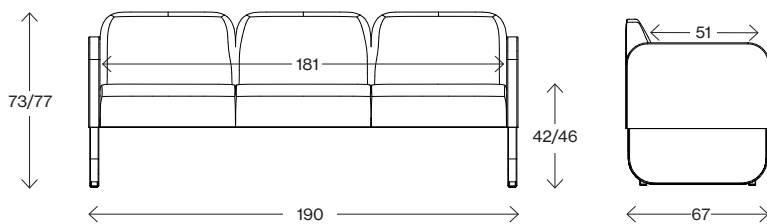

**3-seater with armrests**

Weight (kg) 56,2

# Facts

## Bail

Measurements cm

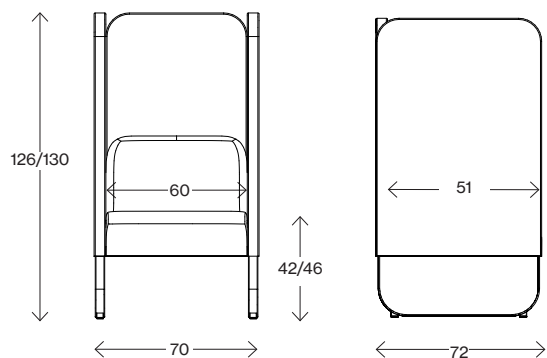

1-seater, screen back, screen side

Weight (kg) 47,1

Measurements cm

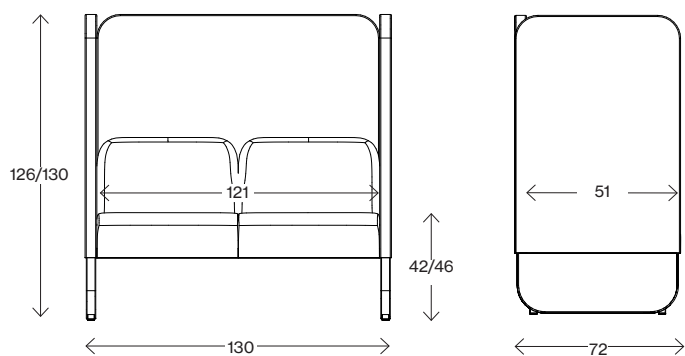

2-seater , screen back, screen side

Weight (kg) 69,6

Measurements cm

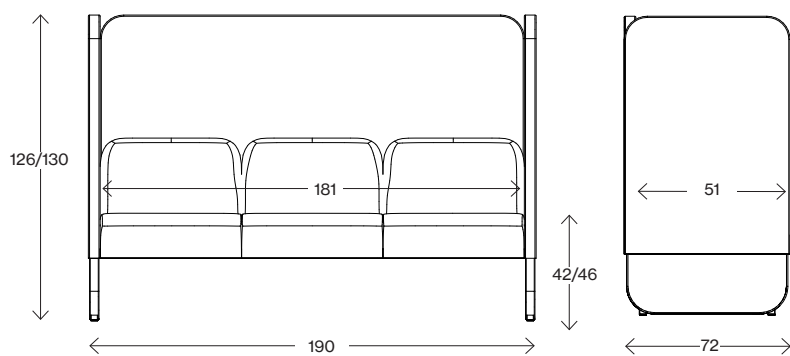

3-seater ,screen back, screen side

Weight (kg) 92,2

# Facts

## Bail

Measurements cm

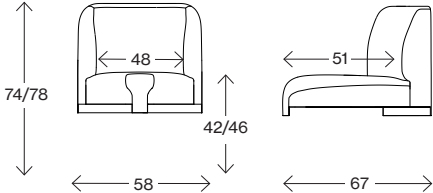

**Bail Corner 45°**

Weight (kg) XX

Measurements cm

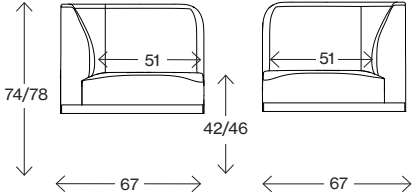

**Bail Corner 90°, straight**

Weight (kg) 19,8

Measurements cm

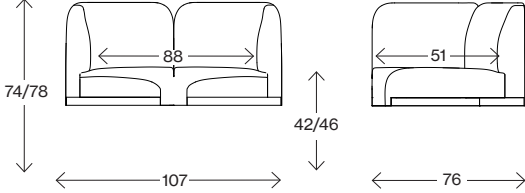

**Bail Corner 90°, round**

Weight (kg) 21,4

# Facts

## Bail

Measurements cm

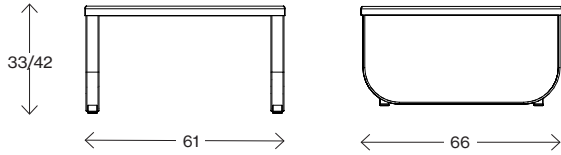

**Bail table 61x66**

Weight (kg) 14,2

Measurements cm

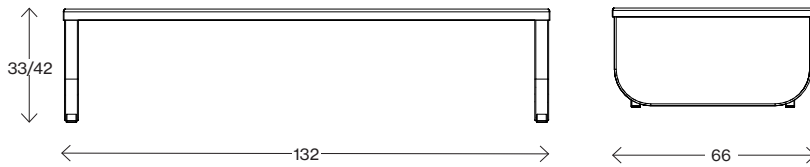

**Bail table 132x66**

Weight (kg) 21,4

Measurements cm

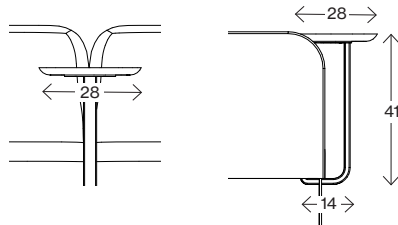

**Bail Coffe table Ø 28**

Weight (kg) 2,4

Measurements cm

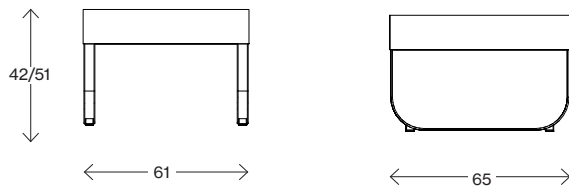

**Bail Garden**

Weight (kg) 17,6

Inner pot 10cm high, in vacuum-formed ABS plastic.





# JOHANSON

---

Johanson Design AB | Anders Anderssons Väg 7 | 285 35 Markaryd | Sweden  
Tel +46-433 725 00 | [www.johansondesign.com](http://www.johansondesign.com)