

Plateau

Design – Böttcher & Kayser



JOHANSON



Introduction

Plateau is a product family that comprises sofas, armchairs and 'seating islands'. The individual pieces work well on their own but can also be combined in groups to create a more dynamic overall impression. The style is uncluttered and uncomplicated. Unnecessary details have been excluded to leave a design that evokes a sense of calm in whatever setting it dignifies.

Plateau has a terrace-like form. The asymmetric structure in each individual item of furniture creates a striking graphic expression. A sensation

of almost hovering in the air. Inviting and, for all its simplicity, spectacular,' say Böttcher-Kayser.

The upholstered elements are held in place by a metal frame, creating an eye-catching combination of varying levels. Plateau is also available without armrests. These can be replaced by a small table that provides a handy surface on which to stand a coffee cup, for example, or perhaps a small computer.

Plateau can be used in a variety of settings, such as waiting rooms and receptions, as a seat for several people in an exhibition hall, or at home in the lounge.



Designer

Böttcher & Kayser is a Berlin-based studio founded in 2007, working in the fields of consumer product, furniture, lighting and interior design. Moritz Böttcher and Nikolaus Kayser have been rewarded with several prestigious awards such as the Interior Innovation Award, several iF Design Awards and numerous Red Dot Awards – including the award, Best of the Best' in 2013. Their projects have been published in books and magazines around the world.



Models



1-seater armrest / table L/R*



2-seater armrest / table L/R*



3-seater armrest / table L/R*



Armchair armrest / table L/R*



Big Island with armrest L/R*

* Armrests and tables can be selected on the right or left.

Models



Plateau table 70x70 H34



Plateau table 70x70 H42



Plateau table 140x70 H34



Plateau table 140x70 H42

Material

Seat - Upholstery materials

Johanson offers a very generous range of fabrics, leather and artificial leather from the most reputable suppliers in the world. Should any other material be desired despite the wide selection, it is also possible to suggest other materials. Johanson does not charge start-up costs for handling non-standard materials.

Multicolour - Finish RAL

Take part in Johanson's color range, 405 variants of different finishes are offered as standard on steel frames and metal details. Choose from all 195 RAL colors, alternatives are available both as solid finish (gloss 72) or Structure finish which has a matte, slightly textured elegant surface. In addition, 15 RAL colors with pearl finish and chrome are offered.

For all colours see www.johansondesign.com

195 Solid collection (gloss 72)

195 Structure collection (matte, textured surface)

15 Pearl finish collection and chrome.



Table top



Plateau Table

Finish

White laminate
 Black laminate
 Light grey laminate
 Oak laminate
 Birch laminate
 Wenge laminate
 Walnut laminate
 Ash laminate
 Oak veneer
 Birch veneer
 Ash veneer
 Formica Collection Colors
 White laminate
 Black laminate
 Black stained oak veneer
 White stained oak veneer
 Black stained ash veneer
 White stained ash veneer
 Abet Laminati
 Abet Laminati
 Abet Laminati
 Fenix NTM laminate
 Fenix NTM laminate
 Fenix NTM laminate
 Fenix NTM laminate
 Formica Collection True Scale
 Formica Collection True Scale
 Formica Collection True Scale
 Formica Collection Patterns
 Formica Collection Colors

Description

F1040 MAT Alpino RAL 9010
 F2253 MAT Diamond black RAL 9011
 F7927 MAT Folkestone NCS S 2500-N
 F5374 NAT Elegant oak
 F7921 MAT Birch
 F1614 MAT Punga Punga Wood
 F5150 MAT American Walnut
 F8843 NAT Natural Ash
 Clear lacquered oak veneer
 Clear lacquered birch veneer
 Clear lacquered ash veneer
 Any color from Formica Collection Colors:
 F1040 MAT Alpino RAL 9010
 F2253 MAT Diamond black RAL 9011
 Black stained lacquered oak veneer
 Oak veneer white pigmented hardwax
 Black stained lacquered ash veneer
 Ash veneer white pigmented hardwax
 Rocks 557 Papier
 Rocks 1451 Papier
 Rocks 596 Climb
 0718 Grigio Londra
 0720 Nero Ingo
 0724 Grigio Bromo
 0752 Grigio Antrim
 F3458 Travertine Silver AR Plus
 F3457 Breccia Paradiso AR Plus
 F3476 Jet Sequoia AR Plus
 F8832 Elemental Corten AHD
 Any color from Formica Collection Colors:

Edge

Discus edge, natural lacq. MDF
 Discus edge, natural lacq. MDF
 Discus edge, natural lacq. MDF
 Discus edge, natural lacq. MDF
 Discus edge, natural lacq. MDF
 Discus edge, natural lacq. MDF
 Discus edge, natural lacq. MDF
 Discus edge, natural lacq. MDF
 Discus edge, natural lacq. MDF
 Discus edge, natural lacq. MDF
 Discus edge, white lacquered MDF
 Discus edge, black MDF
 Discus edge, black stained MDF
 Discus edge, white stained MDF
 Discus edge, black stained MDF
 Discus edge, white stained MDF
 Discus edge, natural lacq. MDF
 Discus edge, natural lacq. MDF
 Discus edge, natural lacq. MDF
 Discus edge, black MDF
 Discus edge, black MDF
 Discus edge, black MDF
 Discus edge, black MDF
 Discus edge, natural lacq. MDF
 Discus edge, natural lacq. MDF
 Discus edge, natural lacq. MDF
 Discus edge, natural lacq. MDF
 Discus edge, natural lacq. MDF
 Discus edge, natural lacq. MDF
 Colour lacquered to match laminate



Plateau with table/armrest

Table top with rounded corners.
 Oak veneer, Black/ White stained oak veneer

Accessories

Electrical equipment

Thanks to the bracket, you can mount a Powerdot Mini with power socket or smart charging with 2 USB-C sockets in the desired location using the included screws.



Bracket



Powerdot bracket mini, single
Black / white



Powerdot bracket mini, double
Black / white

Powerdot



Powerdot Mini Electric
1 power (type F, Schuko)
Black / white



Powerdot Mini USB
2 USB-C PD
(30W/20V/1,5A)
Black / white



Facts

Plateau-in detail

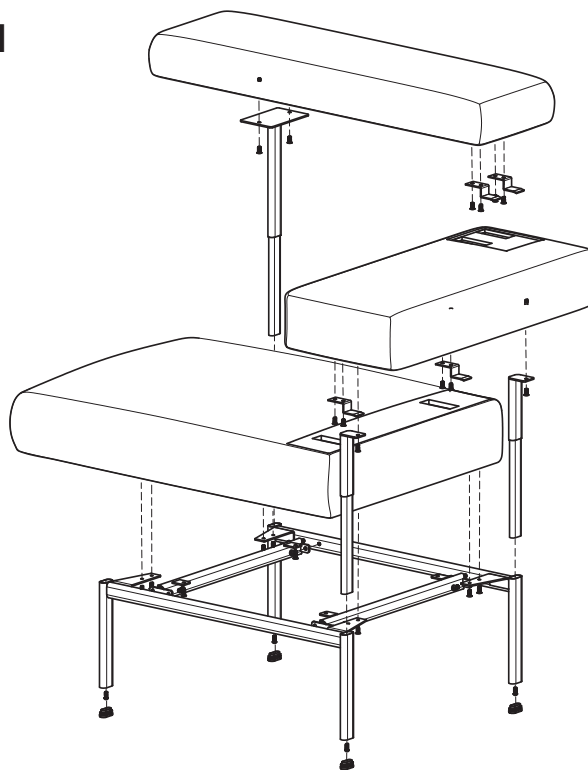

Separable



Material

The seat is made of wood and polyether. Foam which meets the highest fire classification CMHR- Combustion Modified High Resilience, is available for all models on request. The base is made of finished/lacquered metal.

Certificate

- Fire certificate (BS EN 1021-1 & 2)



Recycling

All steel parts are recyclable. Before we finish the chrome/lacquer all grease/oil is removed by alkaline wash and then sent for destruction. The lacquering is produced by electrostatic epoxy powder coating that gives a minimum of waste. The electrostatic chrome (chrome 3) is recyclable. The plastic parts that are used are recyclable by grinding. All upholstery and frames of synthetic material are totally without C.F.C. emissions. All glue is water based.

BIM - objects can be downloaded

at johansondesign.com

 3D Max

 Archicad

 Revit

 Autocad 2D

 Autocad 3D

 Sketchup

 pCon

Facts

Measurements cm

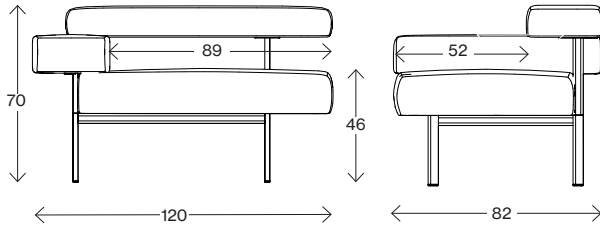

Plateau 1-seater armrest

Weight (kg) -
Volume (m³) -

Measurements cm

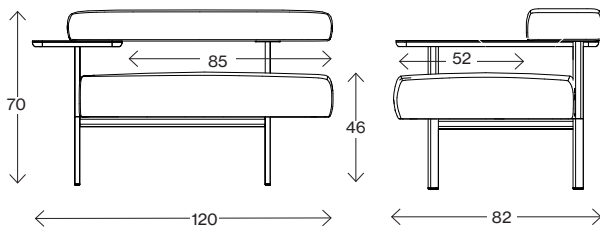

Plateau 1-seater table

Weight (kg) -
Volume (m³) -

Measurements cm

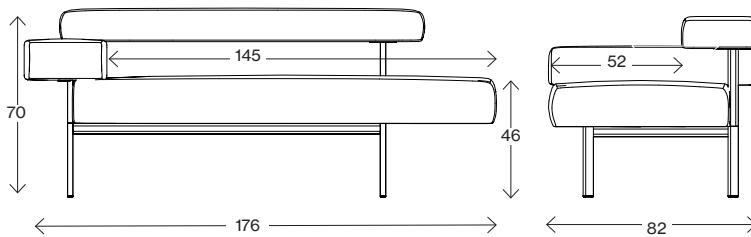

Plateau 2-seater armrest

Weight (kg) -
Volume (m³) -

Measurements cm

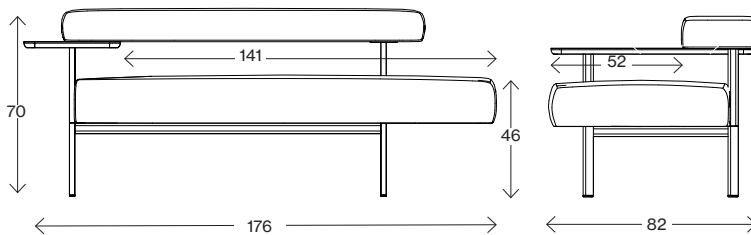

Plateau 2-seater table

Weight (kg) -
Volume (m³) -

Facts

Measurements cm

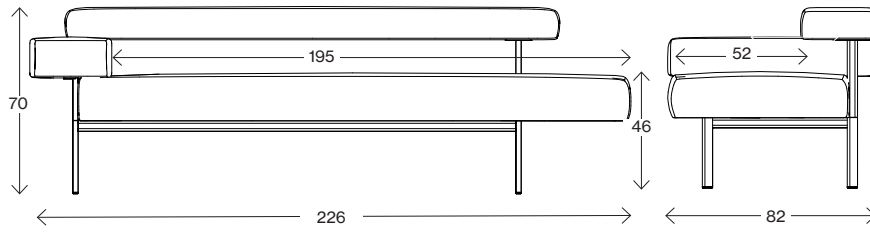

Plateau 3-seater armrest

Weight (kg) -
Volume (m³) -

Measurements cm

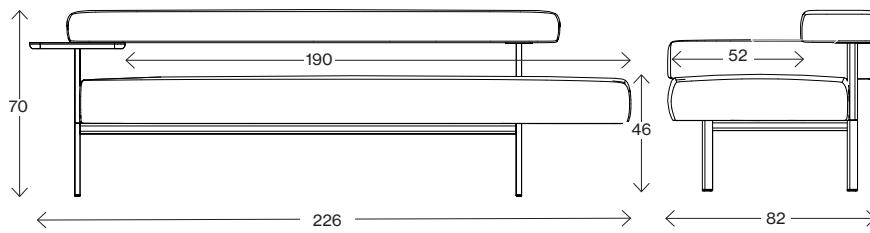

Plateau 3-seater table

Weight (kg) -
Volume (m³) -

Measurements cm

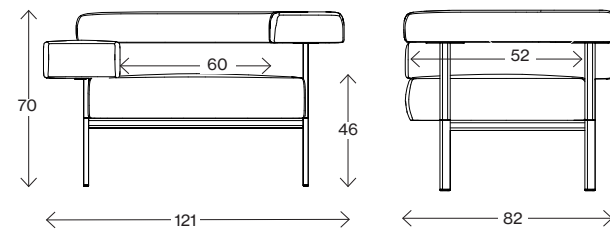

Plateau Armchair armrest

Weight (kg) -
Volume (m³) -

Measurements cm

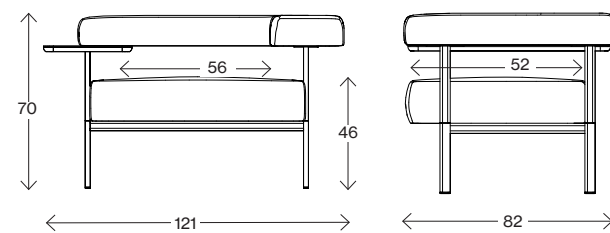

Plateau Armchair table

Weight (kg) -
Volume (m³) -

Measurements cm

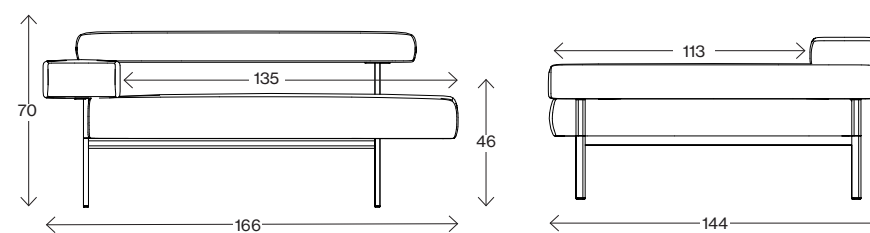

Plateau Big Island

Weight (kg) -
Volume (m³) -

Facts

Measurements cm

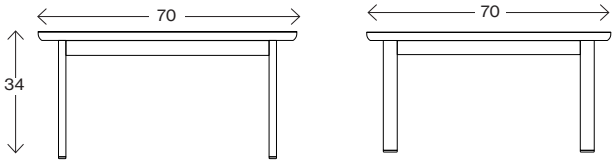

Plateau table 70x70 H34

Weight (kg) -
Volume (m³) -

Measurements cm

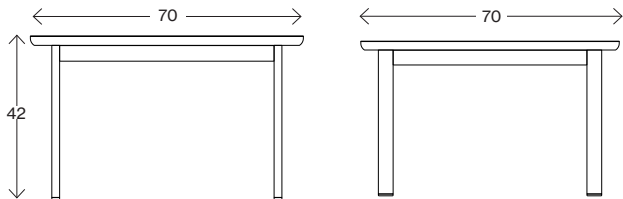

Plateau table 70x70 H42

Weight (kg) -
Volume (m³) -

Measurements cm

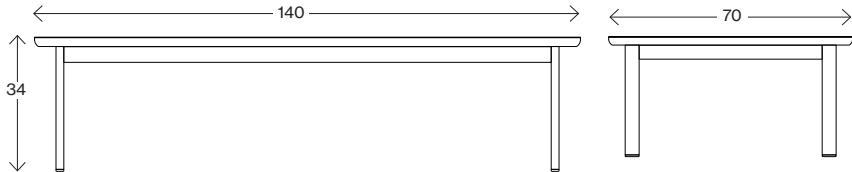

Plateau table 140x70 H34

Weight (kg) -
Volume (m³) -

Measurements cm



Plateau table 140x70 H42

Weight (kg) -
Volume (m³) -









JOHANSON

Johanson Design AB | Anders Anderssons Väg 7 | 285 35 Markaryd | Sweden
Tel +46-433 725 00 | www.johansondesign.com