

Family  
**Pelican**

Design – Johan Lindstén

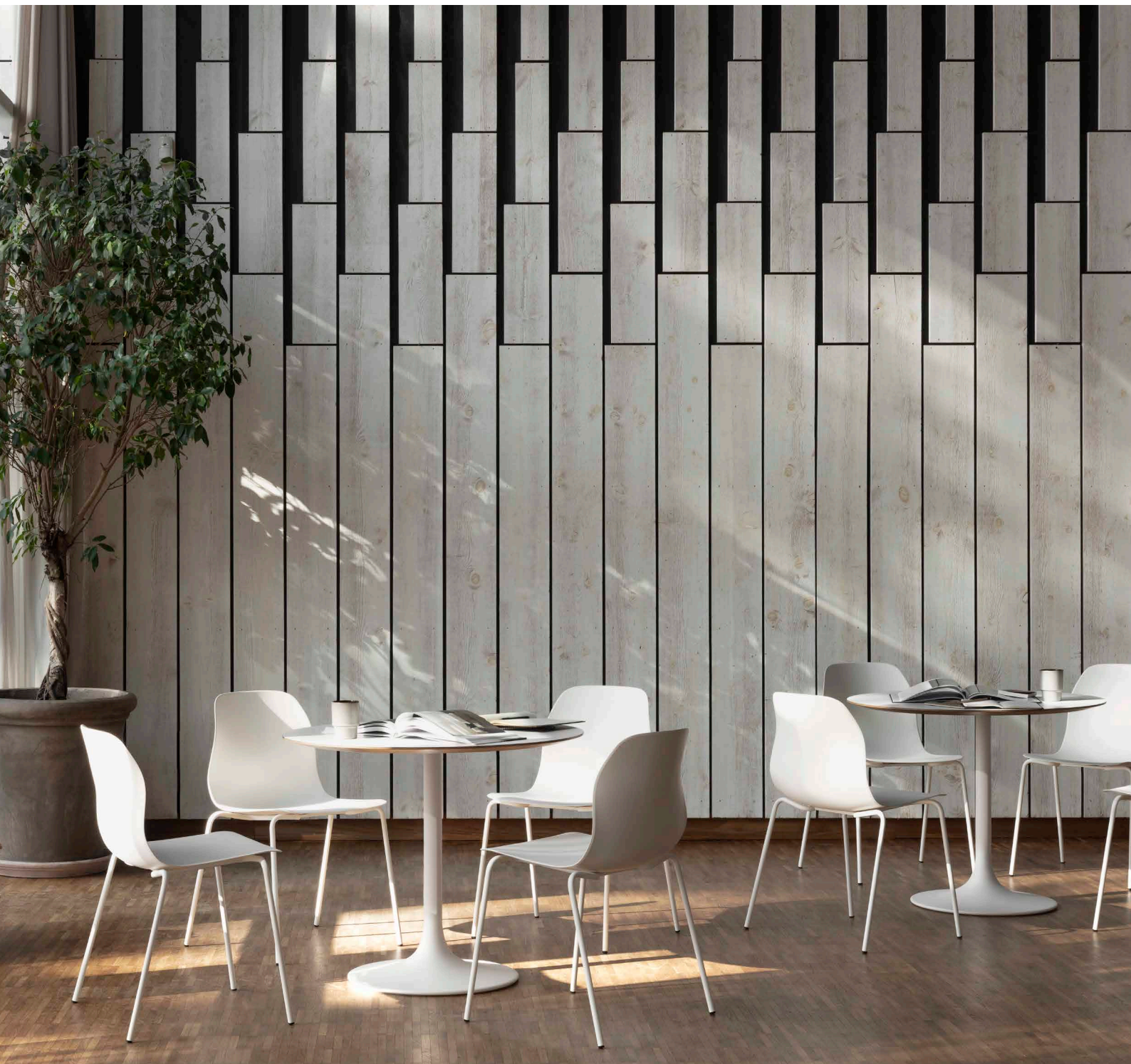

**JOHANSON**



## Introduction

It has long been an ambition to create a chair that offers the very best in seating comfort and yet is not only lightweight and stackable, but also made from recycled materials. Pelican which was launched spring 2020, designed by Johan Lindstén, and is a sleek-looking chair with gently rounded lines produced by recycled plastic materials.

Pelican is the first chair in Sweden to be awarded the EU Ecolabel and is the answer to many customers'

wishes, while challenging attitudes on the choice of materials at a time when sustainability and environmental issues are high on the agenda. We consulted with experts from the plastics, recycling and manufacturing industries at an early stage of the development process, using their collective input to create the best possible foundation on which to build a successful project. The recycled plastic comes from a Swedish supplier.



Pelican - a sleek-looking chair with gently rounded lines produced with recycled plastic materials, and is the first chair in Sweden to be awarded the EU Ecolabel.

## Designer

Johan Lindstén's products are characterised by well-thought out design and unexpected details in a creative process that optimises function. Johan wants his designs to interact with their surroundings in a way that influences the mood of the user. He draws his inspiration from the most unlikely of sources, such as the lilac bush outside his home or the Ocean of Storms on the moon.



# Base

1 Choose model - base and execution

2 Choose model - seat and material, colour and texture

3 Choose accessories

## Four leg base



08-46



08-46 with wheels



08-46 with closed armrests (CA)



08-46 with open armrests (OA)



08-46 Fixed Tablet



## Sled base



09-46



09-46 with armrests (WA)



09-46 with writing tablet

## Swivel base



03-46



03-46 with armrests (WA)



03-46 with wheels\*



03-46 with armrests and wheels\*

\* Available with tilt mechanism and height adjustment

# Base

1 Choose model - base and execution

2 Choose model - seat and material, colour and texture

3 Choose accessories

## Barstool

---



BS 08-65



BS 08-80

# Seat & Material

1 Choose model - base and execution

2 Choose model - seat and material, colour and texture

3 Choose accessories

## Seats

---



Plastic seat

Half covered seat



Covered inside seat



Covered seat

### Plastic seat - colour options



Black RAL 9005

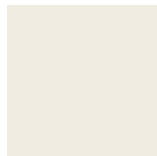

White RAL 9010



Green RAL 6013



Light Grey RAL 7004



Dark Grey RAL 7012



Beige RAL 1019



Pink RAL 3012



Wine Red RAL 3005



Red RAL 3016



Blue RAL 5001



Yellow RAL 1005

Above colors for Pelican seat shells are standard.  
In addition to these, we can offer the seat shells in all other RAL colors.  
For more information please contact our customer support.

# Seat & Material

1 Choose model - base and execution

2 Choose model - seat and material, colour and texture

3 Choose accessories

## Seat - Upholstery materials

Johanson offers a very generous range of fabrics, leather and artificial leather from the most reputable suppliers in the world. Should any other material be desired despite the wide selection, it is also possible to suggest other materials. Johanson does not charge start-up costs for handling non-standard materials.

## Multicolour - Finish RAL

Take part in Johanson's color range, 405 variants of different finishes are offered as standard on steel frames and metal details. Choose from all 195 RAL colors, alternatives are available both as solid finish (gloss 72) or Structure finish which has a matte, slightly textured elegant surface. In addition, 15 RAL colors with pearl finish and chrome or polished aluminum are offered.

For all colours see [www.johansondesign.com](http://www.johansondesign.com)

195 Solid collection (gloss 72)

195 Structure collection (matte, textured surface)

15 Pearl finish collection

Chrome (08, 09- base)

Polished aluminum (03-base).



Legs 08-wood

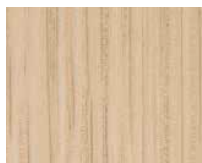

Oak



White stained oak



Black stained oak

# Accessories

1 Choose model - base and execution

2 Choose model - seat and material, colour and texture

3 Choose accessories



## Connector

08-base



## Wheels

Wheels for 03-base in black, white and chrome.



## Connector

09-base



## Fixed Tablet (08-46)

Fixed writing tablet in CDF. White with black core. Writing tablet is supplied for right-handed as standard and left-handed as alternative.



## Stacking trolley

Stackability for each chair can be found under facts.



## Writing tablet (09-46)

Practical foldable writing tablet in CDF. White with black core. Writing tablet is supplied for right-handed as standard and left-handed as alternative.

With the chair stacked on our trolley you can easily place and move up to 20 Pelican depending on the choice of base. The Pelican chair with upholstered seat is not suitable for storing stacked as pressure marks may occur.

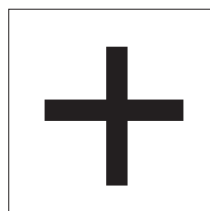
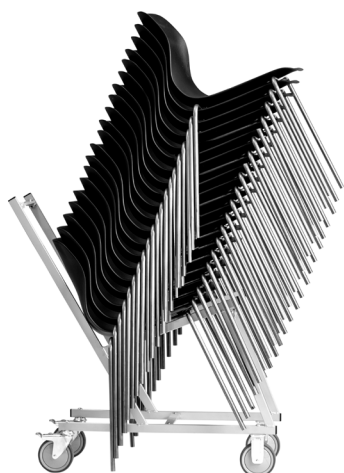

## Extra

Wheels, tilt mechanism and height adjustment for 03-base.  
Quilting  
Felt gliders  
Stacking protection (standard)



“It has long been an ambition to create a chair that offers the very best in seating comfort and yet is not only lightweight and stackable, but also made from recycled materials.”

Johan Lindstén



# Facts

Pelican in detail



Separable

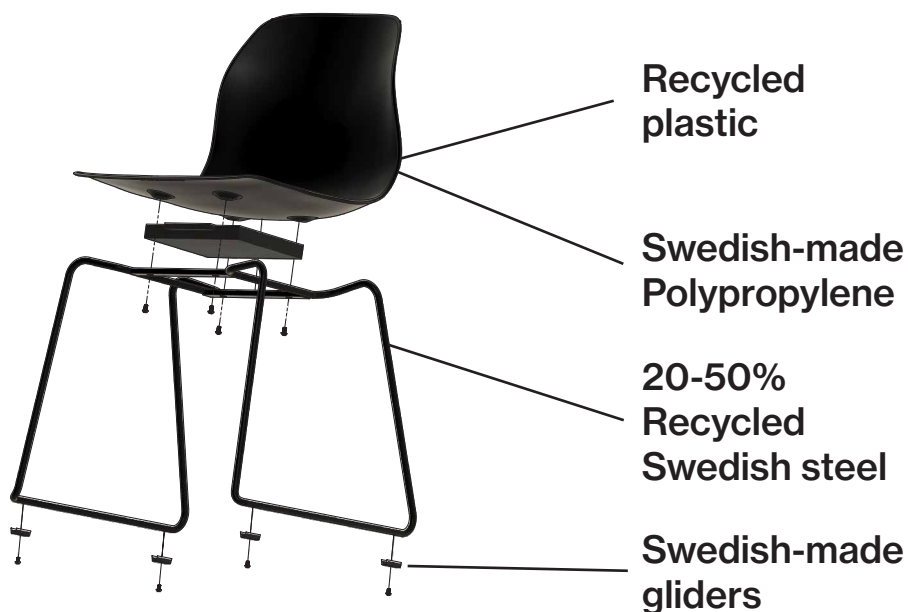

## Facts

### Material

- Recycled PP (Polypropylene).
- Percentage of recycled plastic: 40 – 100 %.
- Reinforcement: 20 % fiberglass.
- The recycled plastic comes from the food industry.
- Stacking protector- 100 % recycled material

### Certificate - Pelican 03,08,09

- Fire certificate (BS EN 1021-1 & 2)

### Recycling

All steel parts are recyclable. Before we finish the chrome/lacquer all grease/oil is removed by alkaline wash and then sent for destruction. The lacquering is produced by electrostatic epoxy powder coating that gives a minimum of waste. The electrostatic chrome (chrome 3) is recyclable. The plastic parts that are used are recyclable by grinding. All upholstery and frames of synthetic material are totally without C.F.C. emissions. All glue is water based.



CERTIFIED  
ISO 14001  
Environmental  
management system

RI  
SE



**BIM - objects can be downloaded**

at [johansondesign.com](http://johansondesign.com)



3D Max



Archicad



Revit



Autocad 2D



Autocad 3D



Sketchup

 pCon

# Facts

## Pelican 03

Measurements cm

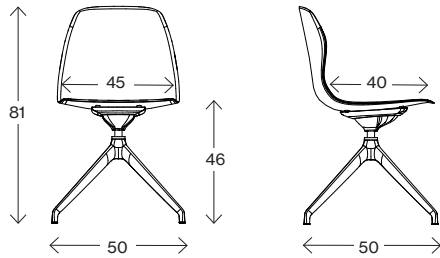

### 03-46

Weight (kg)P/HC/C  
Volume (m<sup>3</sup>)

7,4/8,0/8,2  
0,243

Measurements cm

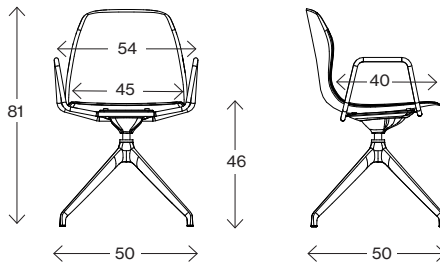

### 03-46 with armrests (WA)

Weight (kg)P/HC/C  
Volume (m<sup>3</sup>)

10,6/11,2/11,4  
0,270

Measurements cm

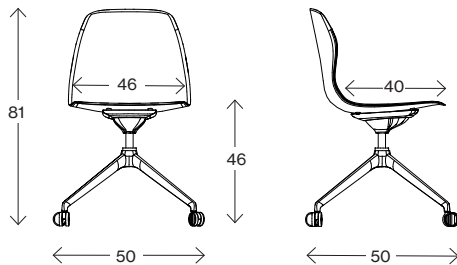

### 03-46 with wheels

Weight (kg)P/HC/C  
Volume (m<sup>3</sup>)  
Height with height adjustment  
Seat height with height adjustment

7,6/8,4/8,6  
0,243  
77 - 88  
42 - 53

The facts also apply to model with tilt and height adjustment.

Measurements cm

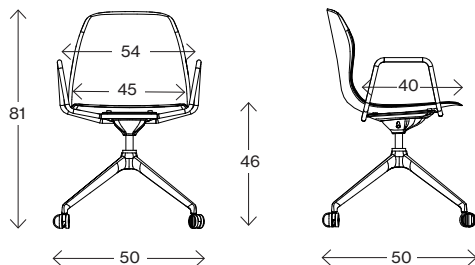

### 03-46 with armrests and wheels

Weight (kg)P/HC/C  
Volume (m<sup>3</sup>)  
Height with height adjustment  
Seat height with height adjustment

11,0/11,6/11,8  
0,315  
77 - 88  
42 - 53

The facts also apply to model with tilt and height adjustment.

# Facts

## Pelican 08

Measurements cm

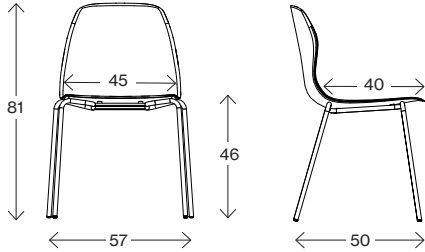

### 08-46

Weight (kg)P/HC/CI/C 4,8/5,4/5,6/5,6  
Volyme (m<sup>3</sup>) 0,270  
Ø Steel (mm) 16



The Pelican chair with upholstered seat is not suitable for storing stacked as pressure marks may occur.

Measurements cm

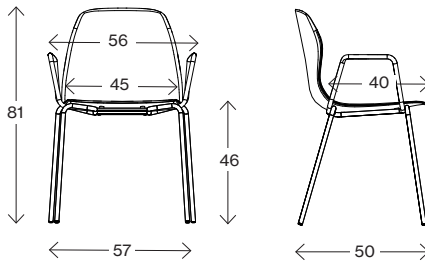

### 08-46 with closed armrests (CA)

Weight (kg)P/HC/CI/C 5,8/6,4/6,6/6,6  
Volyme (m<sup>3</sup>) 0,325  
Ø Steel (mm) 16



The Pelican chair with upholstered seat is not suitable for storing stacked as pressure marks may occur.

Measurements cm

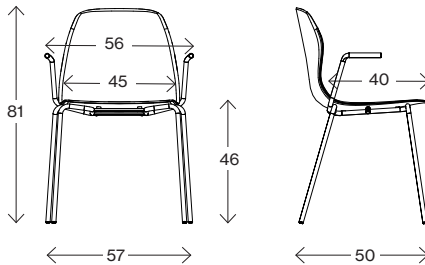

### 08-46 with open armrests (OA)

Weight (kg)P/HC/CI/C 5,2/5,8/6,0/6,0  
Volyme (m<sup>3</sup>) 0,325  
Ø Steel (mm) 16



The Pelican chair with upholstered seat is not suitable for storing stacked as pressure marks may occur.

Measurements cm

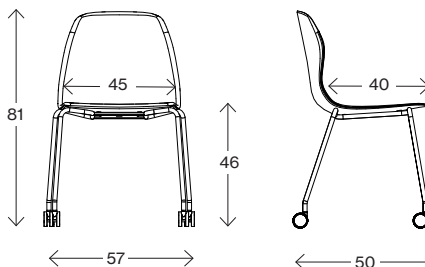

### 08-46 with wheels

Weight (kg)P/HC/CI/C 5,0/5,6/5,8/5,8  
Volyme (m<sup>3</sup>) 0,270  
Ø Steel (mm) 16



The Pelican chair with upholstered seat is not suitable for storing stacked as pressure marks may occur.

# Facts

## Pelican 08

Measurements cm

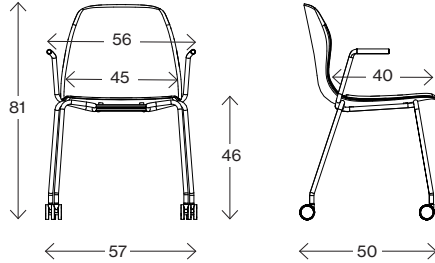

### 08-46 with wheels open armrests (CA)



Weight (kg)P/HC/CI/C	5,4/6,0/6,2/6,2
Volyme (m <sup>3</sup> )	0,325
Ø Steel (mm)	16

The Pelican chair with upholstered seat is not suitable for storing stacked as pressure marks may occur.

Measurements cm

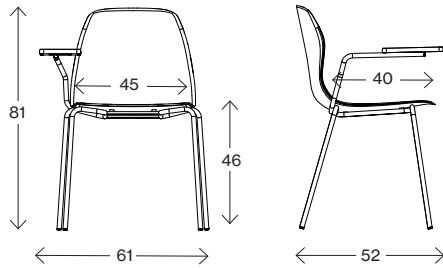

### 08-46 with fixed tablet

Weight (kg)P/HC/CI/C	-
Volyme (m <sup>3</sup> )	0,26
Ø Steel (mm)	16
Table	15x22

Measurements cm

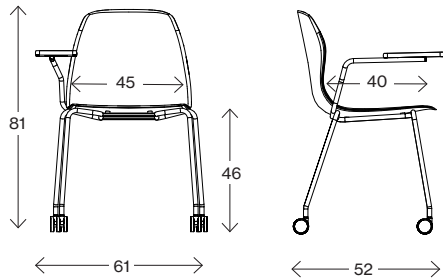

### 08-46 with fixed tablet and wheels

Weight (kg)P/HC/CI/C	-
Volyme (m <sup>3</sup> )	0,26
Ø Steel (mm)	16
Table	15x22

Measurements cm

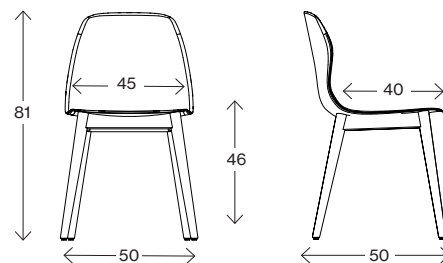

### 08-46 wood

Weight (kg) P/HC/CI/C	5,9/6,6/6,6/6,6
Volyme (m <sup>3</sup> )	0,2

# Facts

## Pelican 09

Measurements cm

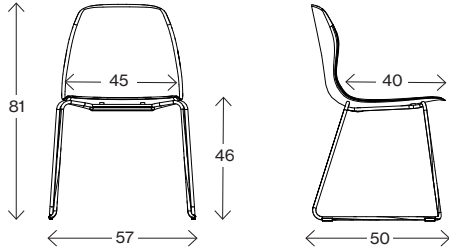

### 09-46

Weight (kg) P/HC/CI/C 4,8/5,2/5,6/5,7  
 Volyme (m<sup>3</sup>) 0,27  
 Ø Steel (mm) 12



The Pelican chair with upholstered seat is not suitable for storing stacked as pressure marks may occur.

Measurements cm

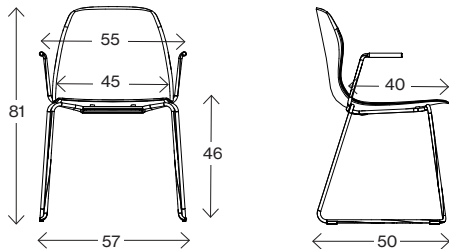

### 09-46 with armrests (WA)

Weight (kg) P/HC/CI/C 5,8/6,2/6,6/6,7  
 Volyme (m<sup>3</sup>) 0,315  
 Ø Steel (mm) 12



The Pelican chair with upholstered seat is not suitable for storing stacked as pressure marks may occur.

Measurements cm

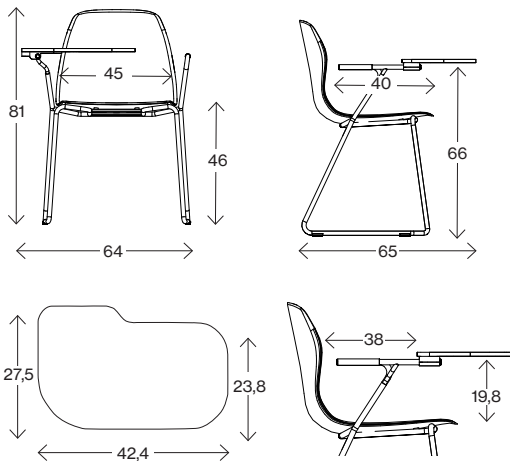

### 09-46 with writing tablet

Weight (kg)P/HC/CI/C 6,8/7,2/7,6/7,7  
 Volyme (m<sup>3</sup>) 0,315  
 Ø Steel (mm) 12



The Pelican chair with upholstered seat is not suitable for storing stacked as pressure marks may occur.

# Facts

## Pelican BS

Measurements cm

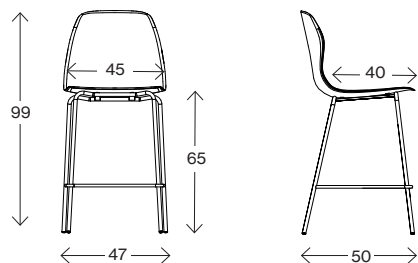

**BS-08-65**

Weight (kg)P/HC/CI/C  
Volyme (m<sup>3</sup>)

5,6/6,0/6,4/6,5  
0,23

Measurements cm

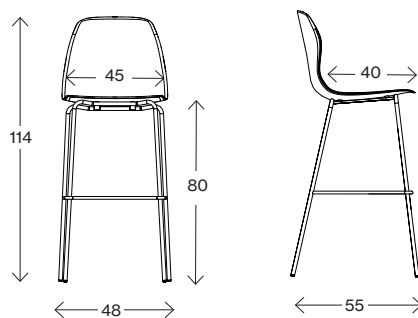

**BS-08-80**

Weight (kg)P/HC/CI/C  
Volyme (m<sup>3</sup>)

6,0/6,4/6,8/6,9  
0,30













# JOHANSON

---

Johanson Design AB | Anders Anderssons Väg 7 | 285 35 Markaryd | Sweden  
Tel +46-433 725 00 | [www.johansondesign.com](http://www.johansondesign.com)