

Family

Peak

Design – Böttcher & Kayser



JOHANSON



Introduction

Peak tables combine a smart construction concept with an appealing expression. By taking the traditional wooden frame and translating it into a more modern interpretation in metal, it has proved possible to produce a supporting structure that is both stable and extremely sturdy.

Peak table, designed by Böttcher & Kayser, is the perfect marriage of an ingenious construction with a strong personality. Available in a range of different sizes and models, Peak's characteristic feature is the way that the legs converge and overlap at the top. This means that the underframe is strong enough to cope with heavy loads and what are, in proportion to its size, (very) large table tops. Thanks to a modern interpretation in metal of an archetypal wooden con-

struction, Peak table series combines contemporary styling with a wide choice of models and sizes. Users can furnish with just one kind of table, or take advantage of the rich diversity that is available and vary their furnishing solution with conference tables of different heights, bar tables, low tables for lounge seating, side tables for small groups and so on. There is a wealth of models for every conceivable situation.

Choose between a more conventional look with an underframe in a metal finish, or liven things up with one or more of the many RAL colours. Tables in the Peak family are available in different lengths, depths and heights in accordance with standard table dimensions, but there is also the possibility of adapting these sizes.



Designer

Böttcher & Kayser is a Berlin-based studio founded in 2007, working in the fields of consumer product, furniture, lighting and interior design. Moritz Böttcher and Nikolaus Kayser have been rewarded with several prestigious awards such as the Interior Innovation Award, several iF Design Awards and numerous Red Dot Awards – including the award, Best of the Best' in 2013. Their projects have been published in books and magazines around the world.



Models

Peak & Peak-XL



Peak - 72



Peak - 90



Peak-XL - 72



Peak-XL - 90



Rectangular

Shape of table top for
Peak and Peak XL

Facts

Peak & Peak-XL

Table heights incl. top of 25mm

Peak - 72

Dimensions cm

For table tops with width 70-99cm

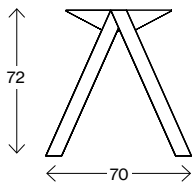

Peak - 90

Dimensions cm

For table tops with width 70-99cm

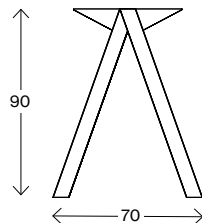

Peak-XL - 72

Dimensions cm

For table tops with width 100-150cm

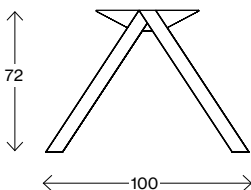

Peak-XL - 90

Dimensions cm

For table tops with width 100-150cm

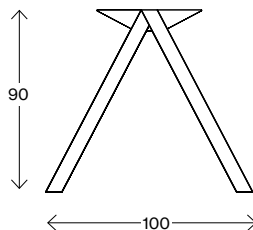

Recommended combinations

Peak & Peak-XL

Choose execution:

1. Length of table top
2. Height of table (72cm / 90cm)
3. Width of table top, for base selection:
Peak: 70-99cm, Peak XL: 100-150cm
4. Peak Middle base / bases for longer tables.
5. Choose Peak connection considered how long overhang you want.

For table tops with length 120-280 cm

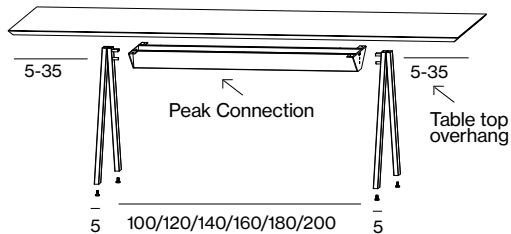

For table tops with length 230-490cm

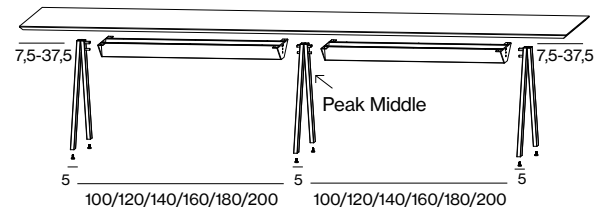

Lenght Connection	100	120	140	160	180	200
Lenght top	Overhang from each side					
120	5	•	•	•	•	•
130	10	•	•	•	•	•
140	15	5	•	•	•	•
150	20	10	•	•	•	•
160	25	15	5	•	•	•
170	30	20	10	•	•	•
180	35	25	15	•	•	•
190	•	30	20	10	•	•
200	•	35	25	15	5	•
210	•	•	30	20	10	•
220	•	•	35	25	15	5
230	•	•	•	30	20	10
240	•	•	•	35	25	15
250	•	•	•	•	30	20
260	•	•	•	•	35	25
270	•	•	•	•	•	30
280	•	•	•	•	•	35

Lenght Connection	100	120	140	160	180	200
Lenght top	Overhang from each side					
230	7,5	•	•	•	•	•
240	12,5	•	•	•	•	•
250	17,5	•	•	•	•	•
260	22,5	•	•	•	•	•
270	27,5	7,5	•	•	•	•
280	32,5	12,5	•	•	•	•
290	37,5	17,5	•	•	•	•
300	•	22,5	•	•	•	•
310	•	27,5	7,5	•	•	•
320	•	32,5	12,5	•	•	•
330	•	37,5	17,5	•	•	•
340	•	•	22,5	•	•	•
350	•	•	27,5	7,5	•	•
360	•	•	32,5	12,5	•	•
370	•	•	37,5	17,5	•	•
380	•	•	•	22,5	•	•
390	•	•	•	27,5	7,5	•
400	•	•	•	32,5	12,5	•
410	•	•	•	37,5	17,5	•
420	•	•	•	•	22,5	•
430	•	•	•	•	27,5	7,5
440	•	•	•	•	32,5	12,5
450	•	•	•	•	37,5	17,5
460	•	•	•	•	•	22,5
470	•	•	•	•	•	27,5
480	•	•	•	•	•	32,5
490	•	•	•	•	•	37,5

Models

Peak Triple, Peak Quattro, Peak Quattro-XL, Peak Quattro-XXL



Peak-Triple - 47



Peak-Triple - 57



Peak-Quattro - 72



Peak-Quattro - 90



Peak-Quattro - 110



Peak-Quattro-XL - 72



Peak-Quattro-XL - 90



Peak-Quattro-XL - 110



Peak-Quattro-XXL - 72

Facts

Peak Triple, Peak Quattro, Peak Quattro-XL, Peak Quattro-XXL

Table heights incl. top of 25mm

Peak - Tripel

Dimensions cm

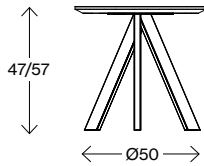

Peak - Quattro

Dimensions cm

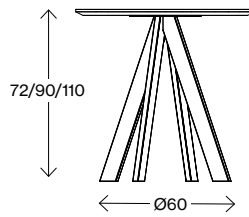

Peak - Quattro - XL

Dimensions cm

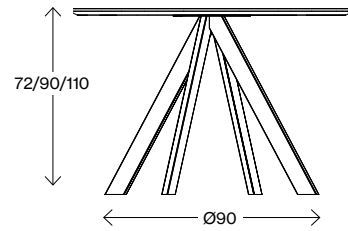

Peak-Quattro-XXL

Dimensions cm

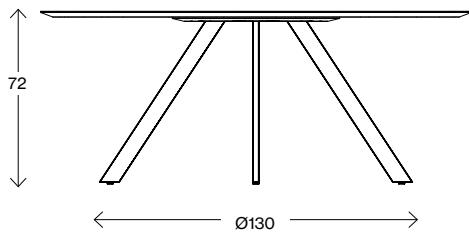

Recommended combinations

Peak Triple, Peak Quattro, Peak Quattro-XL, Peak Quattro-XXL

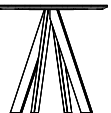
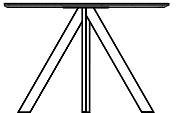
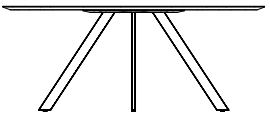
				
Top	Peak-Triple	Peak-Quattro	Peak-Quattro-XL	Peak-Quattro-XXL
Ø50	47/57	-	-	
Ø60	47/57	72/90/110		
Ø75	-	72/90/110		
Ø90/Ø100	-	-	72/90/110	
Ø110/Ø120	-	-	72/90/110	
Ø128				72
Ø150-Ø200				72
60x70	-	72/90/110	-	
70x70	-	72/90/110	-	

Electric equipment

When ordering these products in combination with table tops, the cost for cut out is included in the price. Schuko coupling is delivered as standard.



Powerdot Micro
1 USB-A & 1 USB-C (15,5W/5V/3,1A)
Black / white



Powerdot Mini USB
2 USB-C PD (30W/20V/1,5A)
Black / white



Powerdot Mini Electric
1 power (type F, Schuko)
Black / white



Powerdot Midi
1 power (type F, Schuko) &
1 USB-C PD (30W/20V/1,5A)
Black / white

Powerdot package

Complete with table cover that can be opened from two sides, spacious tray with plenty of space for connectors, Powerdots, textile bag and power strip. The textile bag hides hanging cables in an efficient and discreet way. In combination with Powerdot Electric/Powerdot Electric-USB.

Powerdot package for Peak: Textile bag is not included as cables are stored in the "Peak connection" fixing plate, however, a distance plate is sent with it.



Powerdot Electric
1 power (type F, Schuko) &
4 cable holes
Black



Powerdot Electric USB + charger
1 power (type F, Schuko), 1 USB-A, 1
USB-C (max 60w, 5/9/12/20V, max 3A) &
2 cable holes. Charger for Powerdot.
Black



Powerdot package 31x15cm
Cover and tray in black, white or silver

Powerdot package, 2 Powerdot Electric (2 power)

Powerdot package, 2 Powerdot Electric USB
(2 power, 2 USB-A, 2 USB-C)

Powerdot package, 1 Powerdot Electric and
1 Electric USB (2 power, 1 USB-A, 1 USB-C)

Cable hatch

Practical Cable hatch in the same material as the table top for data and electrical connection, customized to the customer's wishes. We can also provide a practical mounting tray, L370xW200 in silver. Contact Johanson support for info.



Facts

Peak in detail

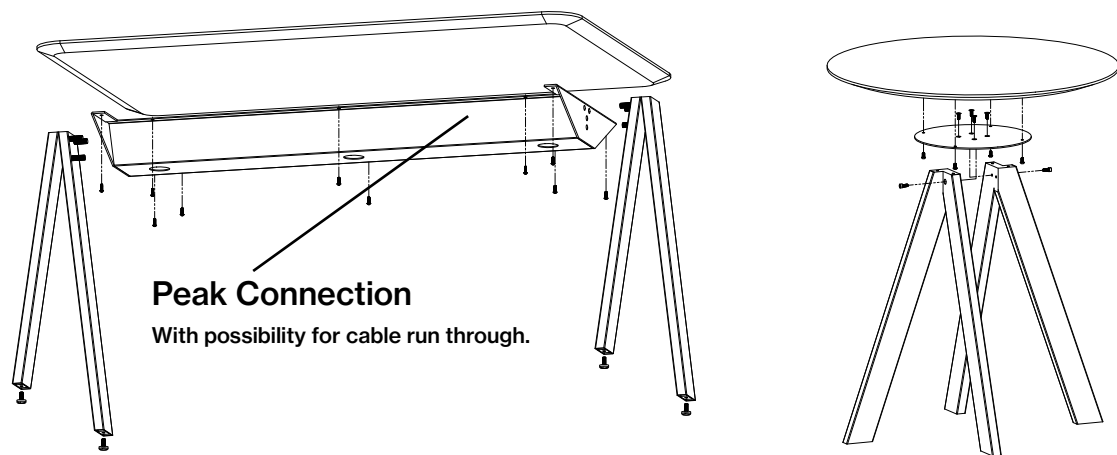

Facts

Material

- 20-50% Recycled Swedish steel
- Underneath each leg there is a plastic glider

Certifikat



BIM -objects can be downloaded
www.johansondesign.com

 3D Max

 Archicad

 Revit

 Autocad 2D

 Autocad 3D

 Sketchup

 pCon

Recycling

All steel parts are recyclable. Before we finish the chrome/lacquer all grease/oil is removed by alkaline wash and then sent for destruction. The lacquering is produced by electrostatic epoxy powder coating that gives a minimum of waste. The electrostatic chrome (chrome 3) is recyclable. The plastic parts that are used are recyclable by grinding. All upholstery and frames of synthetic material are totally without C.F.C. emissions. All glue is water based.

Models

Peak Bench



Peak Bench 46-120



Peak Bench 46-120 Table



Peak Bench 65-120



Peak Bench 46-180



Peak Bench 46-180 Table



Peak Bench 46-180



Peak Bench 46-240



Peak Bench 46-240 Table



Peak Bench 65-240

Colour

Multicolour - Finish RAL

Take part in Johanson's color range, 399 variants of different finishes are offered as standard on steel frames and metal details. Choose from all 192 RAL colors, alternatives are available both as solid finish (gloss 72) or Structure finish which has a matte, slightly textured elegant surface. In addition, 15 RAL colors with pearl finish are offered.

For all colours see www.johansondesign.com

192 Solid collection (gloss 72)

192 Structure collection (matte, textured surface)

15 Pearl finish collection



Table top



Basic

Straight edge with thickness 25mm.



Discus

Chamfered edge with thickness 25mm. MDF with laminate or veneer in different executions.

Other

Besides our standard range of veneer, laminate, stain and lacquer-colours we can offer customized solutions.

Facts

Peak Bench

Dimensions cm

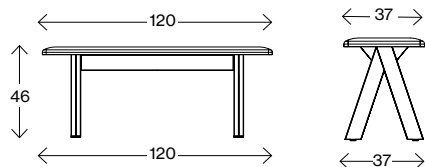

Peak Bench 46 - 120

Weight (kg) -
Volume (m³) 0,20

Dimensions cm

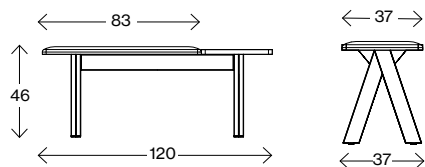

Peak Bench 46 - 120 Table

Weight (kg) -
Volume (m³) 0,20

Dimensions cm

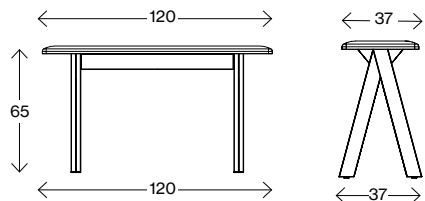

Peak Bench 65 - 120

Weight (kg) -
Volume (m³) 0,29

Dimensions cm



Peak Bench 46 - 180

Weight (kg) -
Volume (m³) 0,31

Dimensions cm

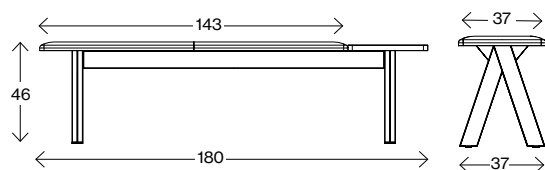

Peak Bench 46 - 180 Table

Weight (kg) -
Volume (m³) 0,31

Facts

Peak Bench

Dimensions cm

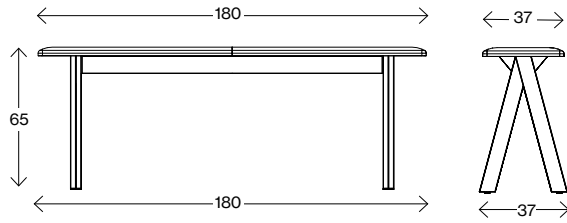

Peak Bench 65 - 180

Weight (kg) -
Volume (m³) 0,43

Dimensions cm

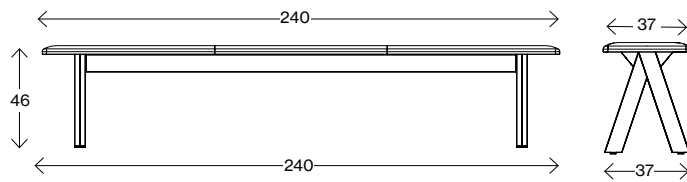

Peak Bench 46 - 240

Weight (kg) -
Volume (m³) 0,41

Dimensions cm

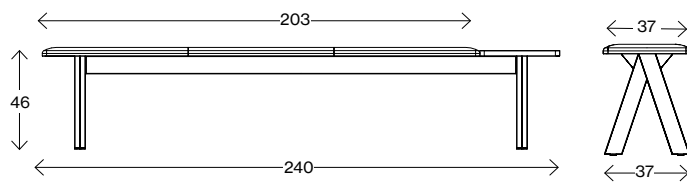

Peak Bench 46 - 240 Table

Weight (kg) -
Volume (m³) 0,41

Dimensions cm

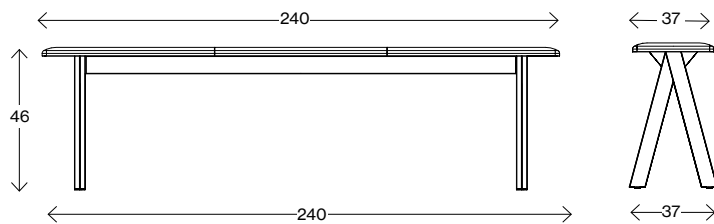

Peak Bench 65 - 240

Weight (kg) -
Volume (m³) 0,41















JOHANSON

Johanson Design AB | Anders Anderssons Väg 7 | 285 35 Markaryd | Sweden
Tel +46-433 725 00 | www.johansondesign.com