

Charlie

Design – Fredrik Färg & Emma Blanche



JOHANSON



Introduction

The close collaboration between Johanson and Färg & Blanche continues to produce results. This spring, for instance, marks a new stage in the development of the Parker concept, this time in the form of a modular sofa with the name Charlie.

“The idea for CHARLIE stems from the Parker Stool that we designed for Johanson some years ago. We were working on sketches for new modular sofa concepts when we realised that Parker stool had already laid the foundations for a whole new series of seating furniture. It was as simple

as that!” say Färg & Blanche, when describing what led them to embark on this expansion of the series. After some experimentation with the “waist” ring that is the hallmark of the PARKER design, the new sofa was ready with an appearance to match that of the popular stool.

The ambition with CHARLIE has been to make it possible to create various configurations to suit different requirements. The current solution combines versatility and flexibility to ensure CHARLIE is at home in all sorts of settings while still retaining its own unique character.



Designer

Stockholm based design studio Färg & Blanche is known for their experimental stance, where each expression informs the other, they effortlessly move between the exclusive hand made one off and the industrially produced, without ever losing their distinctive touch.



Model



Charlie



Charlie Corner



Charlie Corner 45°



Charlie Sofa



Charlie Corner 45° with back



Charlie Single



Charlie Table



Charlie Table XL



Charlie Table Ø90

Electric equipment



Powerdot Micro
1 USB-A & 1 USB-C
(15,5W/5V/3,1A)
Black / white



Powerdot Mini USB
2 USB-C PD
(30W/20V/1,5A)
Black / white



Powerdot Mini Electric
1 power (type F, Schuko)
Black / white



Powerdot Midi
1 power (type F, Schuko) & 1 USB-C PD
(30W/20V/1,5A)
Black / white

Always placed on the right side unless otherwise specified.



Material

Seat - Upholstery materials

Johanson offers a very generous range of fabrics, leather and artificial leather from the most reputable suppliers in the world. Should any other material be desired despite the wide selection, it is also possible to suggest other materials. Johanson does not charge start-up costs for handling non-standard materials.

Multicolour - Finish RAL

Take part in Johanson's color range, 405 variants of different finishes are offered as standard on steel frames and metal details. Choose from all 195 RAL colors, alternatives are available both as solid finish (gloss 72) or Structure finish which has a matte, slightly textured elegant surface. In addition, 15 RAL colors with pearl finish are offered.

For all colours see www.johansondesign.com

195 Solid collection (gloss 72)

195 Structure collection (matte, textured surface)

15 Pearl finish collection



Facts

Charlie in detail

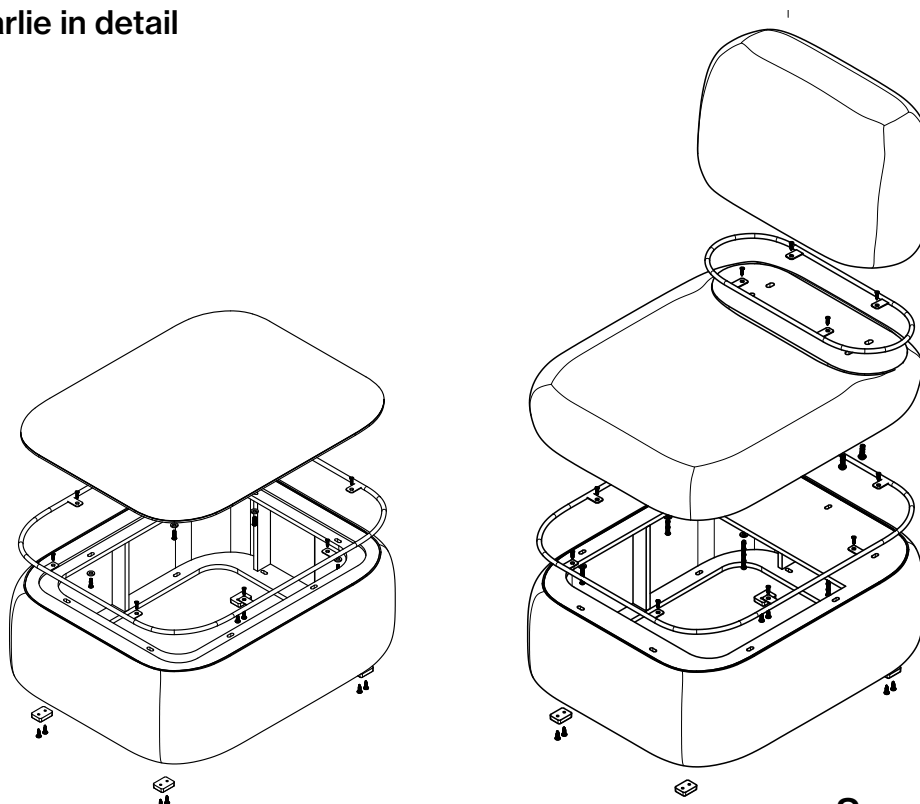

Separable



Material

The seat is made of FSC certified wood and padding is made of polyether/foam. Finished/lacquered metal.

Fire classification

All products meet Möbelfakta's fire requirements. All polyether/foam are tested to Cal TB 117. All standard fabrics meet EN 1021:1 & 2. Other classification, for example BS 5856 (Crib 5) on request, please contact customer support.

Certificate



BIM - objects can be downloaded

at johansondesign.com



3D Max



Autocad 3D



Archicad



Sketchup



Revit



pCon



Autocad 2D

Recycling

All steel parts are recyclable. Before we finish the chrome/lacquer all grease/oil is removed by alkaline wash and then sent for destruction. The lacquering is produced by electrostatic epoxy powder coating that gives a minimum of waste. The electrostatic chrome (chrome 3) is recyclable. The plastic parts that are used are recyclable by grinding. All upholstery and frames of synthetic material are totally without C.F.C. emissions. All glue is water based.

Table top

Finish	Description	Edge
White laminate	F1040 MAT Alpino RAL 9010	Natural lacq. MDF
Black laminate	F2253 MAT Diamond black RAL 9011	Natural lacq. MDF
Light grey laminate	F7927 MAT Folkestone NCS S 2500-N	Natural lacq. MDF
Oak laminate	F5374 NAT Elegant oak	Natural lacq. MDF
Birch laminate	F7921 MAT Birch	Natural lacq. MDF
Wenge laminate	F1614 MAT Punga Punga Wood	Natural lacq. MDF
Walnut laminate	F5150 MAT American Walnut	Natural lacq. MDF
Ash laminate	F8843 NAT Natural Ash	Natural lacq. MDF
Oak veneer	Clear lacquered oak veneer	Natural lacq. MDF
Birch veneer	Clear lacquered birch veneer	Natural lacq. MDF
Ash veneer	Clear lacquered ash veneer	Natural lacq. MDF
Formica Collection Colors	Any color from Formica Collection Colors:	Natural lacq. MDF
White laminate	F1040 MAT Alpino RAL 9010	White lacquered MDF
Black laminate	F2253 MAT Diamond black RAL 9011	Black MDF
Black stained oak veneer	Black stained lacquered oak veneer	Black stained MDF
White stained oak veneer	Oak veneer white pigmented hardwax	White stained MDF
Black stained ash veneer	Black stained lacquered ash veneer	Black stained MDF
White stained ash veneer	Ash veneer white pigmented hardwax	Natural lacq. MDF
Abet Laminati	Rocks 557 Papier	Natural lacq. MDF
Abet Laminati	Rocks 1451 Papier	Natural lacq. MDF
Abet Laminati	Rocks 596 Climb	Natural lacq. MDF
Fenix NTM laminate	0718 Grigio Londra	Black MDF
Fenix NTM laminate	0720 Nero Ingo	Black MDF
Fenix NTM laminate	0724 Grigio Bromo	Black MDF
Fenix NTM laminate	0752 Grigio Antrim	Black MDF
Formica Collection True Scale	F3458 Travertine Silver AR Plus	Natural lacq. MDF
Formica Collection True Scale	F3457 Breccia Paradiso AR Plus	Natural lacq. MDF
Formica Collection True Scale	F3476 Jet Sequoia AR Plus	Natural lacq. MDF
Formica Collection Patterns	F8832 Elemental Corten AHD	Natural lacq. MDF
Formica Collection Colors	Any color from Formica Collection Colors:	Colour lacquered to match laminate



Facts

Measurements cm

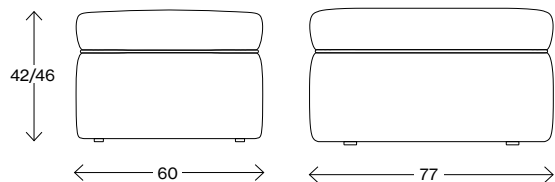

Charlie

Weight (kg) 14,16/17,75

Measurements cm

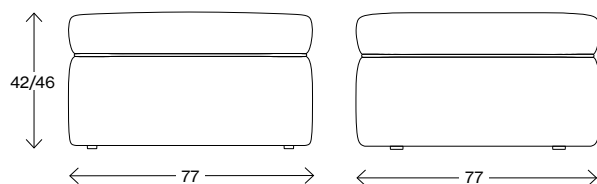

Charlie Corner

Weight (kg) 17,76/20,15

Measurements cm

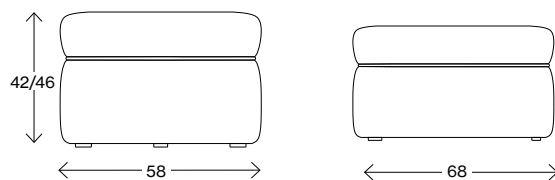

Charlie Corner 45°

Weight (kg) 13,36/15,75

Measurements cm

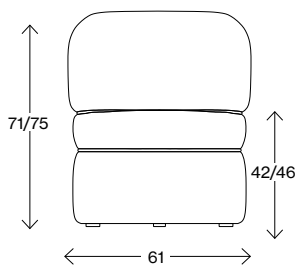

Charlie Corner 45° with back

Weight (kg) 18,15/20,15

Measurements cm

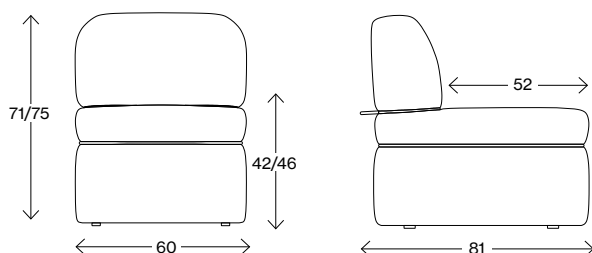

Charlie Singel

Weight (kg) 21,96/24,35

Facts

Measurements cm

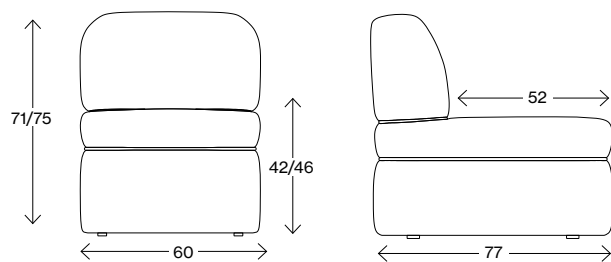

Charlie Sofa

Weight (kg) 21,95/23,95

Measurements cm

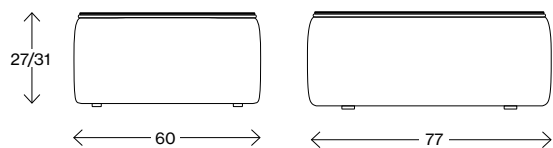

Charlie Table

Weight (kg) 13,5/14,5

Measurements cm

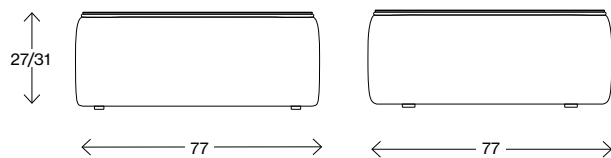

Charlie Table XL

Weight (kg) 17,9/19

Measurements cm

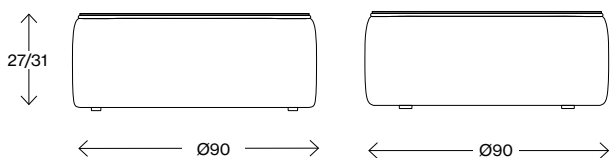

Charlie Table 90Ø

Weight (kg) 15,8













JOHANSON

Johanson Design AB | Anders Anderssons Väg 7 | 285 35 Markaryd | Sweden
Tel +46-433 725 00 | www.johansondesign.com