

Family

Poodle

Design – Anna Herrmann & Alexander Lervik



JOHANSON



Introduction

The Poodle is a series with a strong, highly individualistic expression, with the various items sharing the sibling characteristics of gently rounded forms and a welcoming personality. The bold design is strikingly different, yet the look feels agreeably familiar, thanks to a flirt with historic lines. After first being exhibited in the autumn, Poodle easy chair and chair are now being launched on the market and will be followed later in the year by three sizes of matching tables.

The series was initially unveiled in autumn 2022 as part of the PLUS1 project. This project is an initiative from the designer Alexander Lervik that aims to give young female talents an opportunity to be seen in the otherwise male dominated design industry. The Poodle is the successful outcome of the very first PLUS1 project, undertaken with Anna Herrmann. With the chairs now available for sale, Johanson Design

is also proud to present a new series of three tables that exhibit the same distinctive design characteristics.

In the words of Anna Herrmann herself, “Our aim has been to build on the personality and charisma that are the defining attributes of real-life poodles, and to increase the size of our own Poodle family.” The tables exhibit their own strong identity, making them eye-catching as stand-alones, while form and expression are further accentuated when the tables are teamed up with Poodle chairs.

A distinctive feature of the series, shared by both chairs and tables alike, is the covered legs that stand proud and steady on the underlying surface. Legs can be covered in a wide variety of textiles. This creates opportunities for the furnishings to exert a strong presence as a statement piece in any context, or to blend seamlessly into the rest of the setting.



Designer



Alexander Lervik is one of Sweden's most well-known designers, collaborating with several national and international producers.

Throughout the years, Lervik has received several awards, amongst them Red Dot award, Best of The Best at 100% design, +1 Best in show at Stockholm Furniture fair, Utmärkt Svensk Form and the prestigious award Design S. He is represented at Nasjonalmuseum in Oslo, Nationalmuseum in Stockholm and the design museum Rhössa in Gothenburg, Sweden.



With both German and Swedish origins, Anna Herrmann combines her heritage in her work resulting in functional, yet artistic products.

During her studies, she started her design studio in Munich, where she works on new lighting, furniture, and interior designs. She has designed several children's products, combining a playful expression with a free creative process, often lacking in conventional design. "When appropriate, I allow my playfulness to be a method to design."

Models



Poodle Chair - Metal legs



Poodle Chair - Covered legs



Poodle EC

Material

Seat - Upholstery materials

Johanson offers a very generous range of fabrics, leather and artificial leather from the most reputable suppliers in the world. Should any other material be desired despite the wide selection, it is also possible to suggest other materials. Johanson does not charge start-up costs for handling non-standard materials.

Multicolour - Finish RAL

Take part in Johanson's color range, 405 variants of different finishes are offered as standard on steel frames and metal details. Choose from all 195 RAL colors, alternatives are available both as solid finish (gloss 72) or Structure finish which has a matte, slightly textured elegant surface. In addition, 15 RAL colors with pearl finish and chrome or polished aluminum are offered.

For all colours see www.johansondesign.com

195 Solid collection (gloss 72)

195 Structure collection (matte, textured surface)

15 Pearl finish collection



Facts

Poodle in detail



Separable

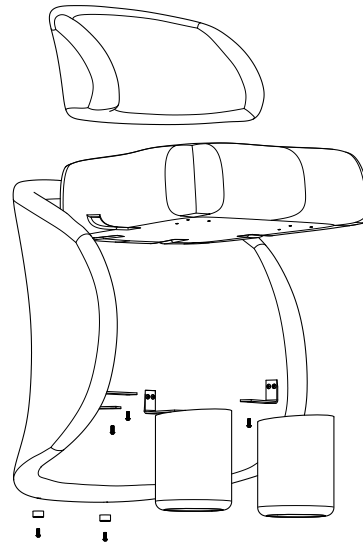
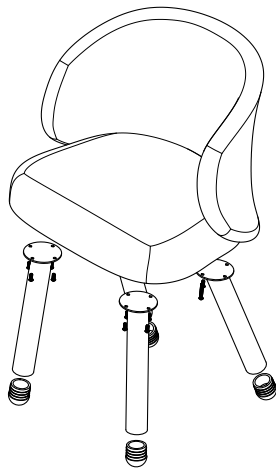

Material

Fully upholstered chair/armchair with moulded seat frame in polyether. FSC certified wood and padding is made of polyether/foam. The base is made of finished/lacquered metal (Poodle chair).







Fire classification

All products meet Möbelfakta's fire requirements. All polyether/foam are tested to Cal TB 117. All standard fabrics meet EN 1021:1 & 2. Other classification, for example BS 5856 (Crib 5) on request, please contact customer support.

Recycling

All steel parts are recyclable. Before we finish the chrome/lacquer all grease/oil is removed by alkaline wash and then sent for destruction. The lacquering is produced by electrostatic epoxy powder coating that gives a minimum of waste. The electrostatic chrome (chrome 3) is recyclable. The plastic parts that are used are recyclable by grinding. All upholstery and frames of synthetic material are totally without C.F.C. emissions. All glue is water based.

BIM - objects can be downloaded
at johansondesign.com

- | | | | |
|---|------------|---|------------|
|  | 3D Max |  | Autocad 3D |
|  | Archicad |  | Sketchup |
|  | Revit |  | pCon |
|  | Autocad 2D | | |

Facts

Measurements cm

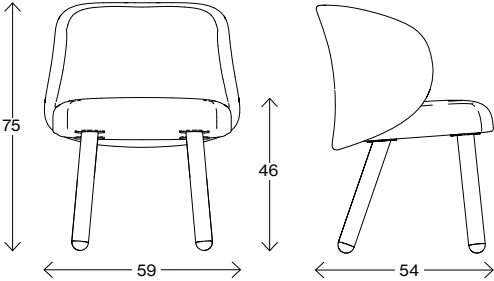

Poodle Chair

Weight (kg) 11
Volume (m³)

Measurements cm

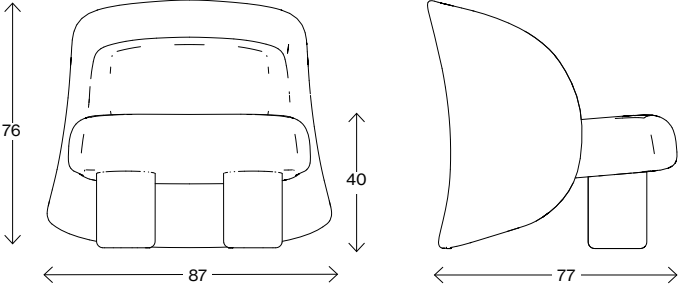

Poodle EC

Weight (kg) 22,8
Volume (m³)











JOHANSON

Johanson Design AB | Anders Anderssons Väg 7 | 285 35 Markaryd | Sweden
Tel +46-433 725 00 | www.johansondesign.com