

Family
Pelican

Design – Johan Lindstén



JOHANSON



Introduction

It has long been an ambition to create a chair that offers the very best in seating comfort and yet is not only lightweight and stackable, but also made from recycled materials. Pelican which was launched spring 2020, designed by Johan Lindstén, and is a sleek-looking chair with gently rounded lines produced by recycled plastic materials.

Pelican is the first chair in Sweden to be awarded the EU Ecolabel and is the answer to many customers'

wishes, while challenging attitudes on the choice of materials at a time when sustainability and environmental issues are high on the agenda. We consulted with experts from the plastics, recycling and manufacturing industries at an early stage of the development process, using their collective input to create the best possible foundation on which to build a successful project. The recycled plastic comes from a Swedish supplier.



Pelican - a sleek-looking chair with gently rounded lines produced with recycled plastic materials, and is the first chair in Sweden to be awarded the EU Ecolabel.

Designer

Johan Lindstén's products are characterised by well-thought out design and unexpected details in a creative process that optimises function. Johan wants his designs to interact with their surroundings in a way that influences the mood of the user. He draws his inspiration from the most unlikely of sources, such as the lilac bush outside his home or the Ocean of Storms on the moon.



Base

- 1 Choose model - base and execution
- 2 Choose model - seat and material, colour and texture
- 3 Choose accessories

Four leg base

Sled base

Swivel base



08-46



09-46



03-46



08-46 with wheels



09-46 with armrests (WA)



03-46 with armrests (WA)



08-46 with closed armrests (CA)



09-46 with writing tablet



03-46 with wheels*



08-46 with open armrests (OA)



03-46 with armrests and wheels*



08-46 Fixed Tablet



* Available with tilt mechanism and height adjustment

Base

1 Choose model - base and execution

2 Choose model - seat and material, colour and texture

3 Choose accessories

Barstool



BS 08-65



BS 08-80

Seat & Material

1 Choose model - base and execution

2 Choose model - seat and material, colour and texture

3 Choose accessories

Seats



Plastic seat



Half covered seat



Covered inside seat



Covered seat

Plastic seat - colour options



Black RAL 9005

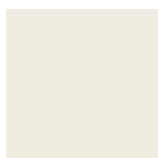

White RAL 9010



Green RAL 6013



Light Grey RAL 7004



Dark Grey RAL 7012



Beige RAL 1019



Pink RAL 3012



Wine Red RAL 3005



Red RAL 3016



Blue RAL 5001



Yellow RAL 1005



Hyacinth Blue -
Curated by TEKLAN
RAL 280 40 45

Above colors for Pelican seat shells are standard.
In addition to these, we can offer the seat shells in all other RAL colors.
For more information please contact our customer support.

Seat & Material

1 Choose model - base and execution

2 Choose model - seat and material, colour and texture

3 Choose accessories

Seat - Upholstery materials

Johanson offers a very generous range of fabrics, leather and artificial leather from the most reputable suppliers in the world. Should any other material be desired despite the wide selection, it is also possible to suggest other materials. Johanson does not charge start-up costs for handling non-standard materials.

Multicolour - Finish RAL

Take part in Johanson's color range, 405 variants of different finishes are offered as standard on steel frames and metal details. Choose from all 195 RAL colors, alternatives are available both as solid finish (gloss 72) or Structure finish which has a matte, slightly textured elegant surface. In addition, 15 RAL colors with pearl finish and chrome or polished aluminum are offered.

For all colours see www.johansondesign.com

195 Solid collection (gloss 72)

195 Structure collection (matte, textured surface)

15 Pearl finish collection

Chrome (08, 09- base)

Polished aluminum (03-base).



Legs 08-wood



Oak



White stained oak



Black stained oak

Accessories

1 Choose model - base and execution

2 Choose model - seat and material, colour and texture

3 Choose accessories



Connector

08-base



Wheels

Wheels for 03-base in black, white and chrome.



Connector

09-base



Fixed Tablet (08-46)

Fixed writing tablet in CDF. White with black core. Writing tablet is supplied for right-handed as standard and left-handed as alternative.



Stacking trolley

Stackability for each chair can be found under facts.



Writing tablet (09-46)

Practical foldable writing tablet in CDF. White with black core. Writing tablet is supplied for right-handed as standard and left-handed as alternative.

With the chair stacked on our trolley you can easily place and move up to 20 Pelican depending on the choice of base. The Pelican chair with upholstered seat is not suitable for storing stacked as pressure marks may occur.

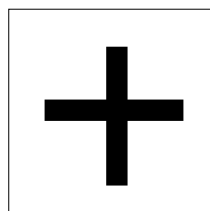
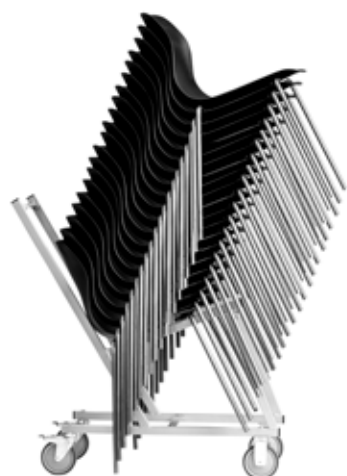

Extra

Quilting
Felt gliders
Stacking protection (standard)



Tilt mechanism and Height adjustment

Height adjustment for 03-base. Pelican is delivered with a Flex-tilt mechanism as standard.

“It has long been an ambition to create a chair that offers the very best in seating comfort and yet is not only lightweight and stackable, but also made from recycled materials.”

Johan Lindstén



Facts

Pelican in detail



Separable

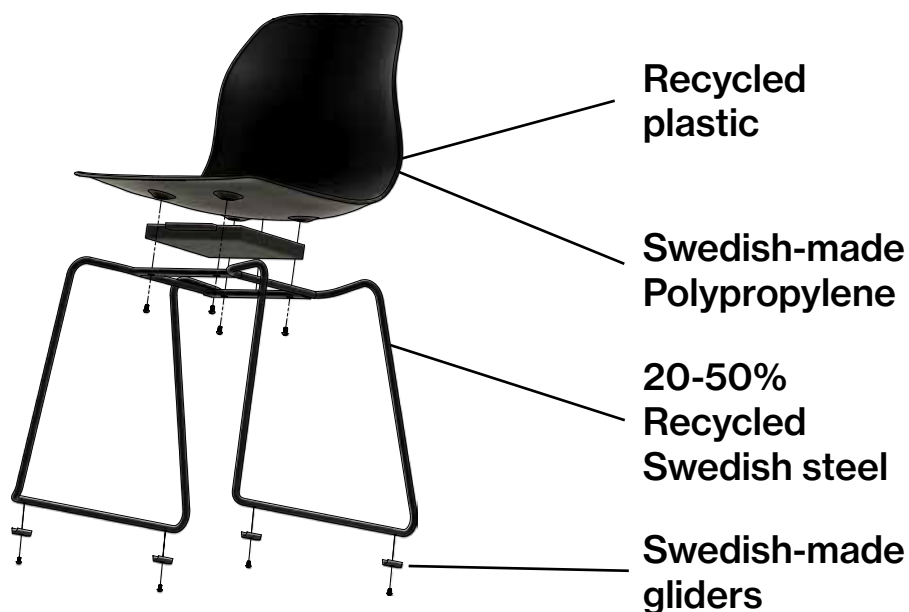

Facts

Material

- Recycled PP (Polypropylene).
- Percentage of recycled plastic: 40 – 100 %.
- Reinforcement: 20 % fiberglass.
- The recycled plastic comes from the food industry.
- Stacking protector- 100 % recycled material

Fire classification

All products meet Möbelfakta's fire requirements. All polyether/foam are tested to Cal TB 117. All standard fabrics meet EN 1021:1 & 2. Other classification, for example BS 5856 (Crib 5) on request, please contact customer support.

Certificate



Recycling

All steel parts are recyclable. Before we finish the chrome/lacquer all grease/oil is removed by alkaline wash and then sent for destruction. The lacquering is produced by electrostatic epoxy powder coating that gives a minimum of waste. The electrostatic chrome (chrome 3) is recyclable. The plastic parts that are used are recyclable by grinding. All upholstery and frames of synthetic material are totally without C.F.C. emissions. All glue is water based.

BIM - objects can be downloaded at johansondesign.com

- 3D Max
- Archicad
- Revit
- Autocad 2D
- Autocad 3D
- Sketchup
- pCon

Facts

Pelican 03

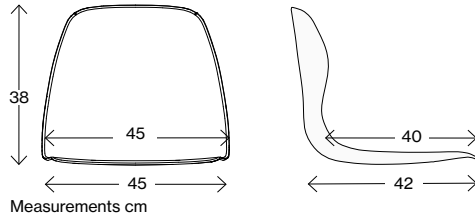

Measurements cm

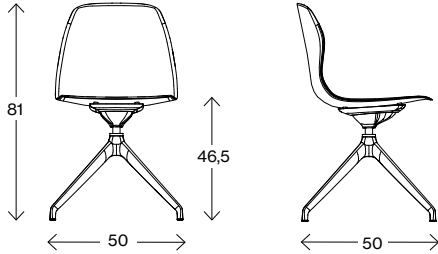

03-46

Weight (kg)P/HC/C
Volume (m³)

7,4/8,0/8,2
0,243

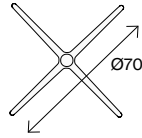

Measurements cm

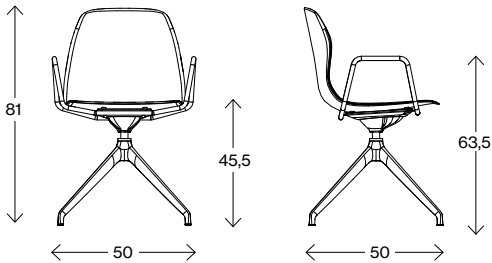

03-46 with armrests (WA)

Weight (kg)P/HC/C
Volume (m³)

10,6/11,2/11,4
0,270

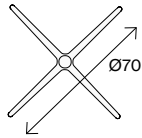

Measurements cm

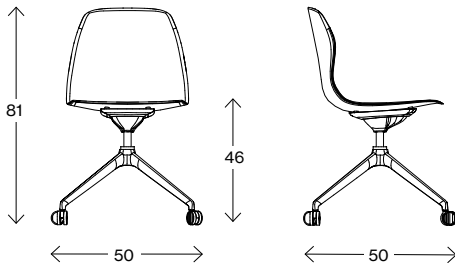

03-46 with wheels

Weight (kg)P/HC/C
Volume (m³)
Height with height adjustment
Seat height with height adjustment

7,6/8,4/8,6
0,243
77 - 88
42 - 53

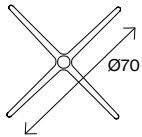

Measurements cm

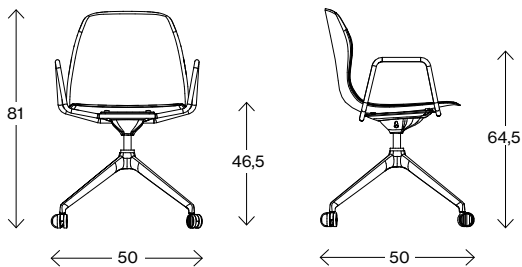

03-46 with armrests and wheels

Weight (kg)P/HC/C
Volume (m³)
Height with height adjustment
Seat height with height adjustment

11,0/11,6/11,8
0,315
77 - 88
42 - 53

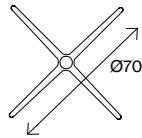

* A covered seat raises the seating height by ca. 1 cm
** The facts also apply to the model with a height-adjustable stand.

Facts

Pelican 05

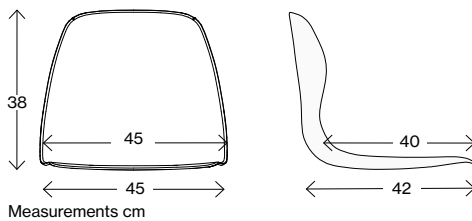

Measurements cm

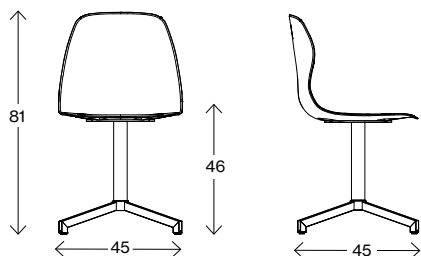

05-46* 4-star base

Weight (kg)P/HC/C
Volume (m³)

7,7
0,218

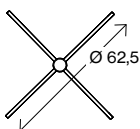

Measurements cm

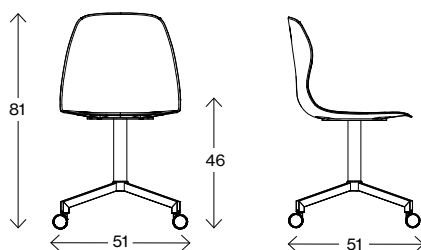

05-46* 4-star base

Weight (kg)P/HC/C
Volume (m³)

7,7
0,218

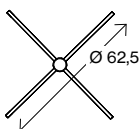

* A covered seat raises the seating height by ca. 1 cm

Facts

Pelican 08

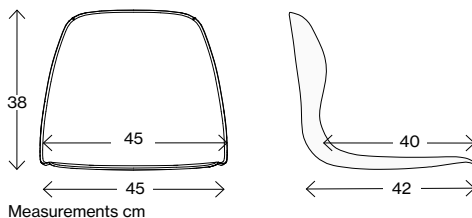

Measurements cm

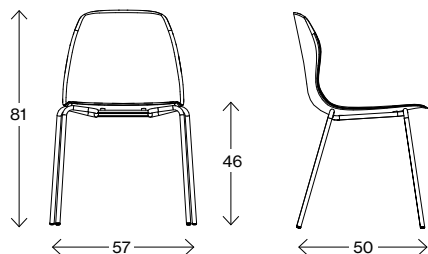

08-46

Weight (kg)P/HC/CI/C 4,8/5,4/5,6/5,6
 Volyme (m³) 0,270
 Ø Steel (mm) 16



The Pelican chair with upholstered seat is not suitable for storing stacked as pressure marks may occur.

Measurements cm

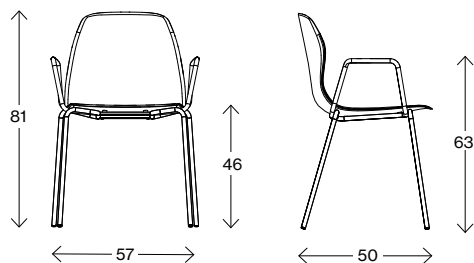

08-46 with closed armrests (CA)

Weight (kg)P/HC/CI/C 5,8/6,4/6,6/6,6
 Volyme (m³) 0,325
 Ø Steel (mm) 16

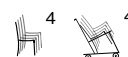

The Pelican chair with upholstered seat is not suitable for storing stacked as pressure marks may occur.

Measurements cm

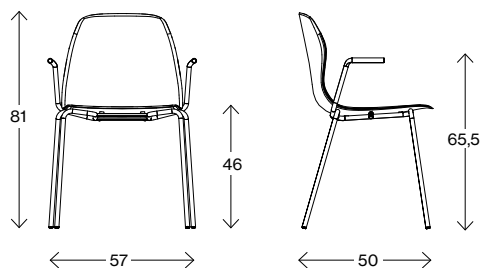

08-46 with open armrests (OA)

Weight (kg)P/HC/CI/C 5,2/5,8/6,0/6,0
 Volyme (m³) 0,325
 Ø Steel (mm) 16



The Pelican chair with upholstered seat is not suitable for storing stacked as pressure marks may occur.

Measurements cm

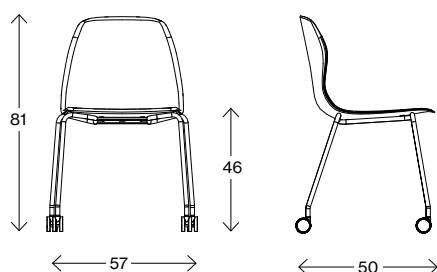

08-46 with wheels

Weight (kg)P/HC/CI/C 5,0/5,6/5,8/5,8
 Volyme (m³) 0,270
 Ø Steel (mm) 16



The Pelican chair with upholstered seat is not suitable for storing stacked as pressure marks may occur.

* A covered seat raises the seating height by ca. 1 cm

Facts

Pelican 08

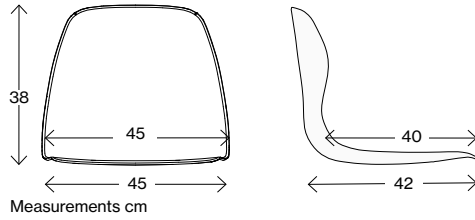

Measurements cm

Measurements cm

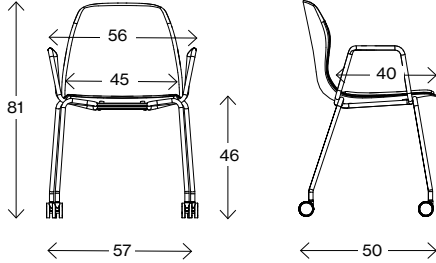

08-46 with wheels closed and armrests (CA)

| | |
|-------------------------|-------------|
| Weight (kg)P/HC/C | 6,0/6,6/6,8 |
| Volym (m ³) | 0,325 |
| Ø Steel (mm) | 16 |



Measurements cm

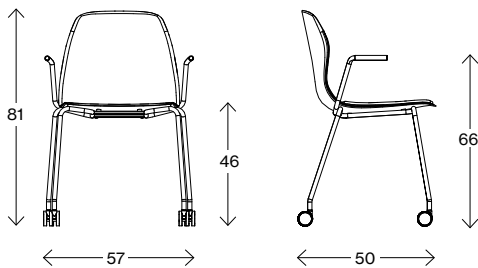

08-46 with wheels open armrests (CA)

| | |
|-------------------------|-----------------|
| Weight (kg)P/HC/CI/C | 5,4/6,0/6,2/6,2 |
| Volym (m ³) | 0,325 |
| Ø Steel (mm) | 16 |



The Pelican chair with upholstered seat is not suitable for storing stacked as pressure marks may occur.

Measurements cm

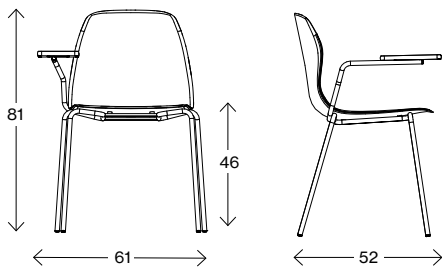

08-46 with fixed tablet

| | |
|-------------------------|-------|
| Weight (kg)P/HC/CI/C | - |
| Volym (m ³) | 0,26 |
| Ø Steel (mm) | 16 |
| Table | 15x22 |

Measurements cm

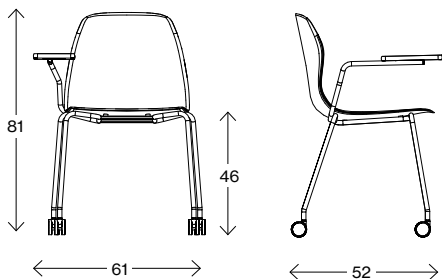

08-46 with fixed tablet and wheels

| | |
|-------------------------|-------|
| Weight (kg)P/HC/CI/C | - |
| Volym (m ³) | 0,26 |
| Ø Steel (mm) | 16 |
| Table | 15x22 |

* A covered seat raises the seating height by ca. 1 cm

Facts

Pelican 08

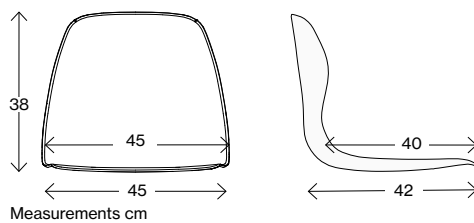

Measurements cm

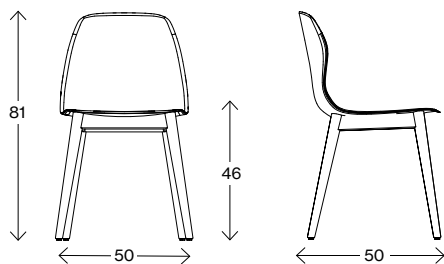

08-46 wood

Weight (kg) P/HC/CI/C
Volyme (m³)

5,9/6,6/6,6/6,6
0,2

* A covered seat raises the seating height by ca. 1 cm

Facts

Pelican 09

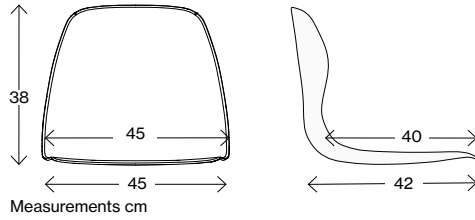

Measurements cm

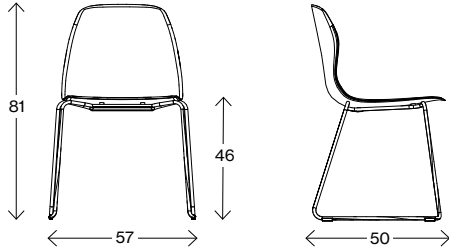

09-46

Weight (kg) P/HC/Cl/C 4,8/5,2/5,6/5,7
 Volyme (m³) 0,27
 Ø Steel (mm) 12



The Pelican chair with upholstered seat is not suitable for storing stacked as pressure marks may occur.

Measurements cm

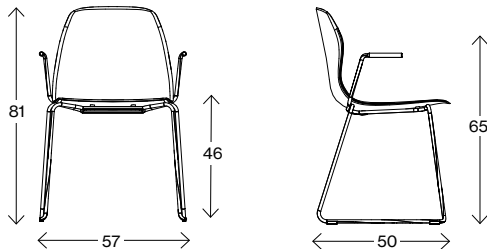

09-46 with armrests (WA)

Weight (kg) P/HC/Cl/C 5,8/6,2/6,6/6,7
 Volyme (m³) 0,315
 Ø Steel (mm) 12



The Pelican chair with upholstered seat is not suitable for storing stacked as pressure marks may occur.

Measurements cm

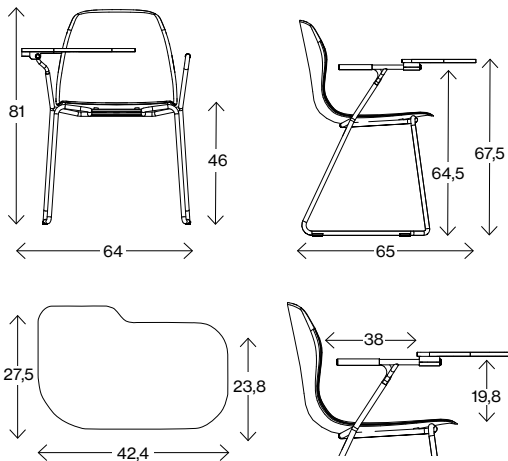

09-46 with writing tablet

Weight (kg)P/HC/Cl/C 6,8/7,2/7,6/7,7
 Volyme (m³) 0,315
 Ø Steel (mm) 12



The Pelican chair with upholstered seat is not suitable for storing stacked as pressure marks may occur.

* A covered seat raises the seating height by ca. 1 cm

Facts

Pelican BS

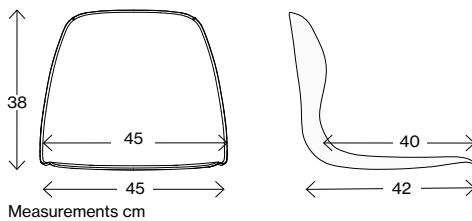

Measurements cm

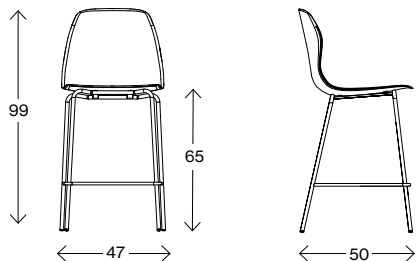

BS-08-65

Weight (kg)P/HC/CI/C
Volyme (m³)

5,6/6,0/6,4/6,5
0,23

Measurements cm

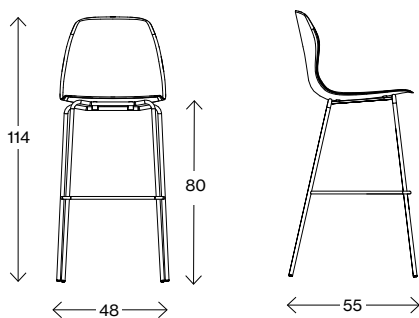

BS-08-80

Weight (kg)P/HC/CI/C
Volyme (m³)

6,0/6,4/6,8/6,9
0,30

* A covered seat raises the seating height by ca. 1 cm











JOHANSON

Johanson Design AB | Anders Anderssons Väg 7 | 285 35 Markaryd | Sweden
Tel +46-433 725 00 | www.johansondesign.com