

Family
Aston

Design – Johan Lindstén



JOHANSON



Introduction

Johanson has enjoyed many years of close collaboration with Johan Lindstén. Now we are proud to add Aston to the many other products in the Johanson range that already bear his name.

Aston is a slender stackable chair. Thanks to the understated elegance of its sleek lines, it can reflect different personalities through the choice fabric and colour of metal frame. The slender silhouette gives ASTON its lightness, while minor details such as the fastenings that connect the legs and back are hidden in the construction. Some inspiration

for Aston has been borrowed from the classic Thonet café chair, whose design remains as practical and appealing today as it has always been. ASTON is the very epitome of design that seeks to minimise the number of components and use techniques such as 3D bending without compromising appearance or comfort in any way.

“With the ASTON series, we aimed to create furniture that is both functional and aesthetically pleasing. The Easy Chair version reinforces this ambition by offering a piece that combines lightness, comfort, and a distinct design identity,” says Johan Lindstén.



Designer

Johan Lindstén's products are characterised by well-thought out design and unexpected details in a creative process that optimises function. Johan wants his designs to interact with their surroundings in a way that influences the mood of the user. He draws his inspiration from the most unlikely of sources, such as the lilac bush outside his home or the Ocean of Storms on the moon.



Models



Aston 08-46



Aston-08-46-Rattan back



Aston 08-46 WA



Aston-08-46-WA-Rattan back



Aston Lounge Covered Back



Aston Lounge Rattan Back

Material

Seat - Upholstery materials

Johanson offers a very generous range of fabrics, leather and artificial leather from the most reputable suppliers in the world. Should any other material be desired despite the wide selection, it is also possible to suggest other materials. Johanson does not charge start-up costs for handling non-standard materials.

Multicolour - Finish RAL

Take part in Johanson's color range, 405 variants of different finishes are offered as standard on steel frames and metal details. Choose from all 195 RAL colors, alternatives are available both as solid finish (gloss 72) or Structure finish which has a matte, slightly textured elegant surface. In addition, 15 RAL colors with pearl finish.

For all colours see www.johansondesign.com

195 Solid collection (gloss 72)

195 Structure collection (matte, textured surface)

15 Pearl finish collection



Rattan backrest

The backrest is made of genuine rattan and is available in three finishes.

- Oak
- White-stained oak
- Black-stained oak



Facts

Aston in detail

Separable

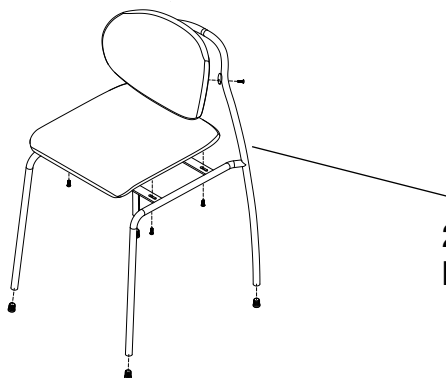

20-50%
Recycled Swedish steel

Material

FSC certified wood.
Padding is made of polyether/foam.
Finished/lacquered metal.

Fire classification

All products meet Möbelfakta's fire requirements. All polyether/foam are tested to Cal TB 117. All standard fabrics meet EN 1021:1 & 2. Other classification, for example BS 5856 (Crib 5) on request, please contact customer support.

Recycling







All steel parts are recyclable. Before we finish the chrome/lacquer all grease/oil is removed by alkaline wash and then sent for destruction. The lacquering is produced by electrostatic epoxy powder coating that gives a minimum of waste. The electrostatic chrome (chrome 3) is recyclable. The plastic parts that are used are recyclable by grinding. All upholstery and frames of synthetic material are totally without C.F.C. emissions. All glue is water based.

Certificate



BIM - objects can be downloaded

at johansondesign.com

-  3D Max
-  Sketchup
-  Archicad
-  pCon
-  Revit
-  Autocad 2D
-  Autocad 3D

Facts

Measurements cm

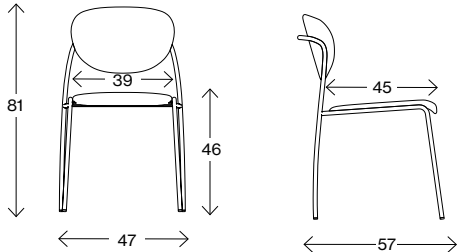

Aston 08-46



Weight (kg) 6,2
Volume (m³) 0,22

Measurements cm

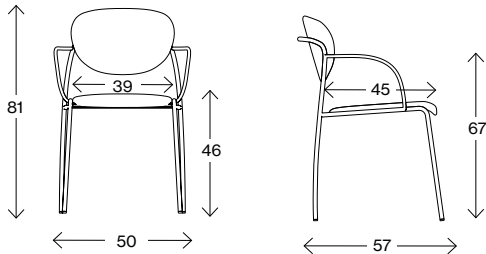

Aston 08-46 WA



Weight (kg) 6,8
Volume (m³) 0,23

Measurements cm

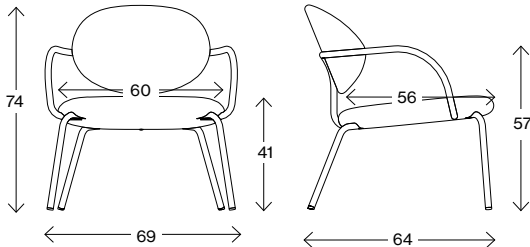

Aston Lounge



Weight (kg) 6,8
Volume (m³) 0,23

Measurements cm

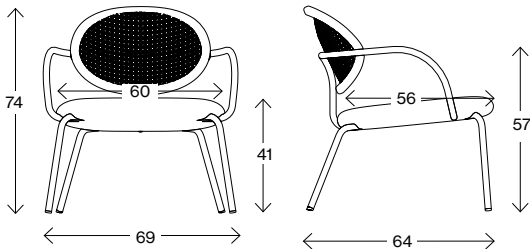

Aston Lounge Rattan Back



Weight (kg) 6,8
Volume (m³) 0,23











JOHANSON

Johanson Design AB | Anders Anderssons Väg 7 | 285 35 Markaryd | Sweden
Tel +46-433 725 00 | www.johansondesign.com