

Plateau

Design – Böttcher & Kayser



JOHANSON



Introduction

Plateau is a product family that comprises sofas, armchairs and 'seating islands'. The individual pieces work well on their own but can also be combined in groups to create a more dynamic overall impression. The style is uncluttered and uncomplicated. Unnecessary details have been excluded to leave a design that evokes a sense of calm in whatever setting it dignifies.

Plateau has a terrace-like form. The asymmetric structure in each individual item of furniture creates a striking graphic expression. A sensation

of almost hovering in the air. Inviting and, for all its simplicity, spectacular,' say Böttcher-Kayser.

The upholstered elements are held in place by a metal frame, creating an eye-catching combination of varying levels. Plateau is also available without armrests. These can be replaced by a small table that provides a handy surface on which to stand a coffee cup, for example, or perhaps a small computer.

Plateau can be used in a variety of settings, such as waiting rooms and receptions, as a seat for several people in an exhibition hall, or at home in the lounge.



Designer

Böttcher & Kayser is a Berlin-based studio founded in 2007, working in the fields of consumer product, furniture, lighting and interior design. Moritz Böttcher and Nikolaus Kayser have been rewarded with several prestigious awards such as the Interior Innovation Award, several iF Design Awards and numerous Red Dot Awards – including the award, Best of the Best' in 2013. Their projects have been published in books and magazines around the world.



Models



1-seater armrest / table L/R*



2-seater armrest / table L/R*



3-seater armrest / table L/R*



Armchair armrest / table L/R*



Big Island with armrest L/R*

* Armrests and tables can be selected on the right or left.

Material

Seat - Upholstery materials

Johanson offers a very generous range of fabrics, leather and artificial leather from the most reputable suppliers in the world. Should any other material be desired despite the wide selection, it is also possible to suggest other materials. Johanson does not charge start-up costs for handling non-standard materials.

Multicolour - Finish RAL

Take part in Johanson's color range, 405 variants of different finishes are offered as standard on steel frames and metal details. Choose from all 195 RAL colors, alternatives are available both as solid finish (gloss 72) or Structure finish which has a matte, slightly textured elegant surface. In addition, 15 RAL colors with pearl finish and chrome are offered.

For all colours see www.johansondesign.com

195 Solid collection (gloss 72)

195 Structure collection (matte, textured surface)

15 Pearl finish collection and chrome.



Accessories

Electrical equipment

Thanks to the bracket, you can mount a Powerdot Mini with power socket or smart charging with 2 USB-C sockets in the desired location using the included screws.



Bracket



Powerdot bracket mini, single
Black / white



Powerdot bracket mini, double
Black / white

Powerdot



Powerdot Mini Electric
1 power (type F, Schuko)
Black / white



Powerdot Mini USB
2 USB-C PD
(30W/20V/1,5A)
Black / white

Connect multiple Powerdots in series using a single connection cable. Series-connected Powerdots are available on request.

Plateau with table/armrest



Table top with rounded corners.
Oak veneer, Black/ White stained oak veneer

Facts

Plateau-in detail

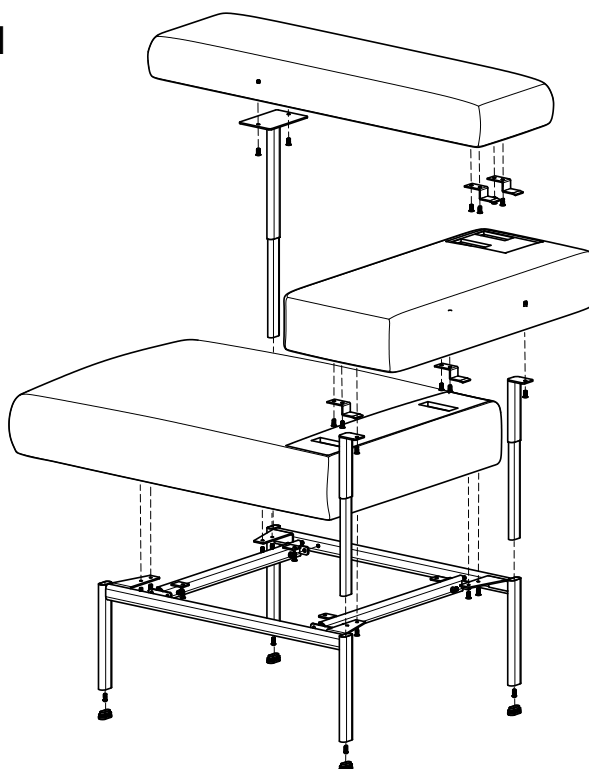

Separable



Material

The seat is made of FSC certified wood and padding is made of polyether/foam. The base is made of finished/lacquered metal.

Fire classification

All products meet Möbelfakta's fire requirements. All polyether/foam are tested to Cal TB 117. All standard fabrics meet EN 1021:1 & 2. Other classification, for example BS 5856 (Crib 5) on request, please contact customer support.

Recycling

All steel parts are recyclable. Before we finish the chrome/lacquer all grease/oil is removed by alkaline wash and then sent for destruction. The lacquering is produced by electrostatic epoxy powder coating that gives a minimum of waste. The electrostatic chrome (chrome 3) is recyclable. The plastic parts that are used are recyclable by grinding. All upholstery and frames of synthetic material are totally without C.F.C. emissions. All glue is water based.

Certificate



CAD - objects can be downloaded

at johansondesign.com



3D Max



Autocad 3D



Archicad



Sketchup



Revit

 pCon



Autocad 2D

Facts

Measurements cm

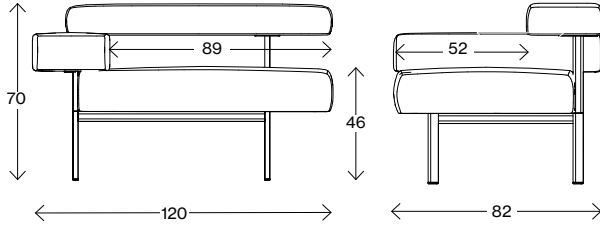

Plateau 1-seater armrest

Weight (kg) -
Volume (m³) -

Measurements cm

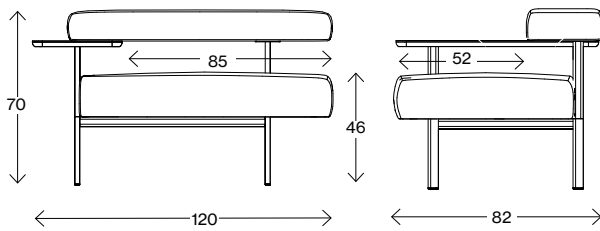

Plateau 1-seater table

Weight (kg) -
Volume (m³) -

Measurements cm

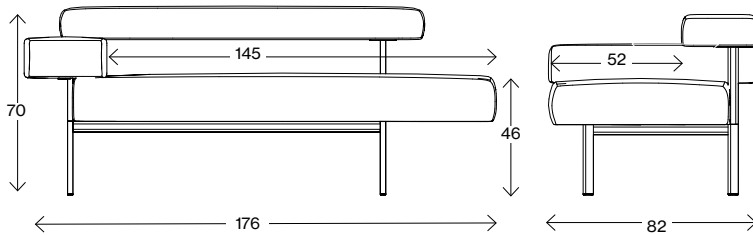

Plateau 2-seater armrest

Weight (kg) 59,5
Volume (m³) -

Measurements cm

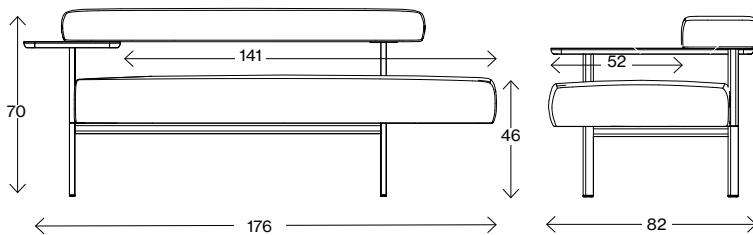

Plateau 2-seater table

Weight (kg) 57
Volume (m³) -

Facts

Measurements cm

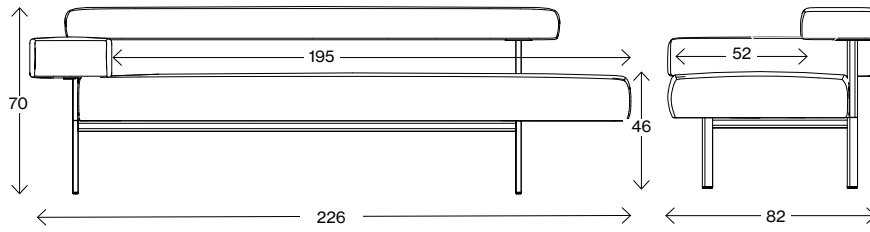

Plateau 3-seater armrest

Weight (kg) -
Volume (m³) -

Measurements cm

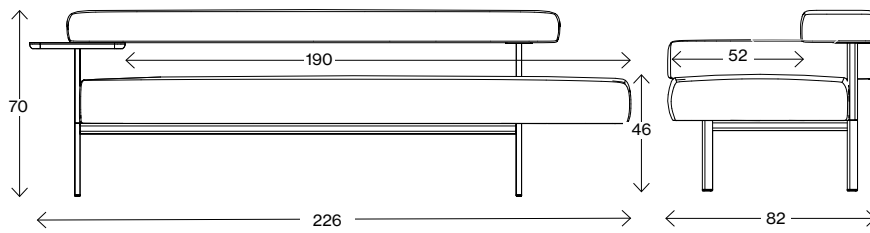

Plateau 3-seater table

Weight (kg) -
Volume (m³) -

Measurements cm

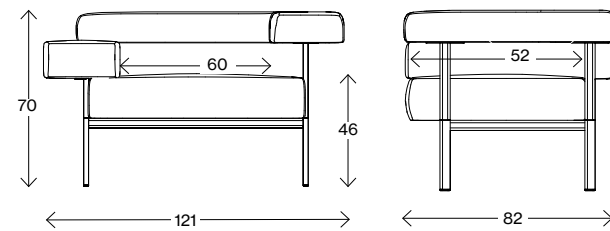

Plateau Armchair armrest

Weight (kg) -
Volume (m³) -

Measurements cm

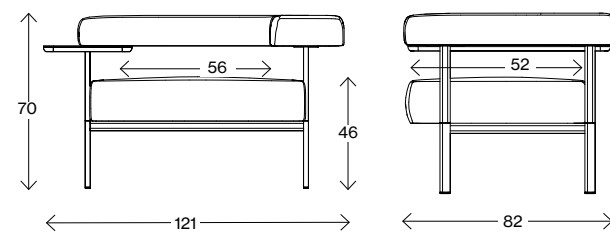

Plateau Armchair table

Weight (kg) -
Volume (m³) -

Measurements cm

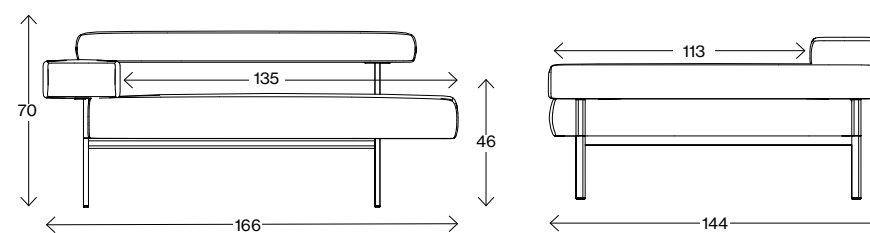

Plateau Big Island

Weight (kg) -
Volume (m³) -







JOHANSON

Johanson Design AB | Anders Anderssons Väg 7 | 285 35 Markaryd | Sweden
Tel +46-433 725 00 | www.johansondesign.com