

Family

Peak

Design – Böttcher & Kayser



JOHANSON



Introduction

Peak tables combine a smart construction concept with an appealing expression. By taking the traditional wooden frame and translating it into a more modern interpretation in metal, it has proved possible to produce a supporting structure that is both stable and extremely sturdy.

Peak table, designed by Böttcher & Kayser, is the perfect marriage of an ingenious construction with a strong personality. Available in a range of different sizes and models, Peak's characteristic feature is the way that the legs converge and overlap at the top. This means that the underframe is strong enough to cope with heavy loads and what are, in proportion to its size, (very) large table tops. Thanks to a modern interpretation in metal of an archetypal wooden con-

struction, Peak table series combines contemporary styling with a wide choice of models and sizes. Users can furnish with just one kind of table, or take advantage of the rich diversity that is available and vary their furnishing solution with conference tables of different heights, bar tables, low tables for lounge seating, side tables for small groups and so on. There is a wealth of models for every conceivable situation.

Choose between a more conventional look with an underframe in a metal finish, or liven things up with one or more of the many RAL colours. Tables in the Peak family are available in different lengths, depths and heights in accordance with standard table dimensions, but there is also the possibility of adapting these sizes.



Designer

Böttcher & Kayser is a Berlin-based studio founded in 2007, working in the fields of consumer product, furniture, lighting and interior design. Moritz Böttcher and Nikolaus Kayser have been rewarded with several prestigious awards such as the Interior Innovation Award, several iF Design Awards and numerous Red Dot Awards – including the award, 'Best of the Best' in 2013. Their projects have been published in books and magazines around the world.



Models

Peak & Peak-XL



Peak - 72



Peak - 90



Peak-XL - 72



Peak-XL - 90



Rectangular

Shape of table top for
Peak and Peak XL

Facts

Peak & Peak-XL

Table heights incl. top of 25mm

Peak - 72

Dimensions cm

For table tops with width 70-99cm

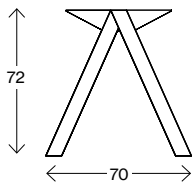

Peak - 90

Dimensions cm

For table tops with width 70-99cm

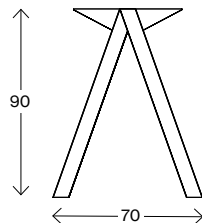

Peak-XL - 72

Dimensions cm

For table tops with width 100-150cm

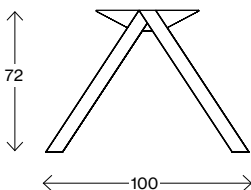

Peak-XL - 90

Dimensions cm

For table tops with width 100-150cm

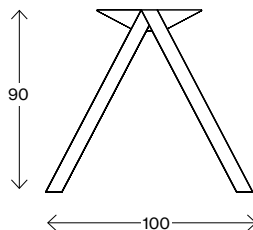

Recommended combinations

Peak & Peak-XL

Choose execution:

1. Length of table top
2. Height of table (72cm / 90cm)
3. Width of table top, for base selection:
Peak: 70-99cm, Peak XL: 100-150cm
4. Peak Middle base / bases for longer tables.
5. Choose Peak connection considered how long overhang you want.

For table tops with length 120-280 cm

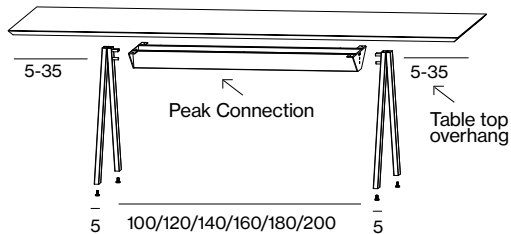

For table tops with length 230-490cm

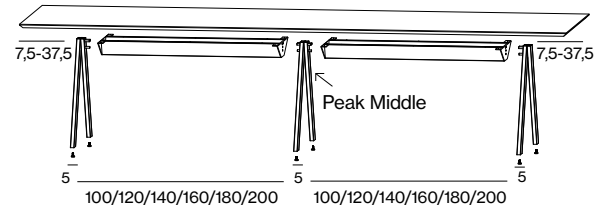

Lenght Connection	100	120	140	160	180	200
Lenght top	Overhang from each side					
120	5	•	•	•	•	•
130	10	•	•	•	•	•
140	15	5	•	•	•	•
150	20	10	•	•	•	•
160	25	15	5	•	•	•
170	30	20	10	•	•	•
180	35	25	15	•	•	•
190	•	30	20	10	•	•
200	•	35	25	15	5	•
210	•	•	30	20	10	•
220	•	•	35	25	15	5
230	•	•	•	30	20	10
240	•	•	•	35	25	15
250	•	•	•	•	30	20
260	•	•	•	•	35	25
270	•	•	•	•	•	30
280	•	•	•	•	•	35

Lenght Connection	100	120	140	160	180	200
Lenght top	Overhang from each side					
230	7,5	•	•	•	•	•
240	12,5	•	•	•	•	•
250	17,5	•	•	•	•	•
260	22,5	•	•	•	•	•
270	27,5	7,5	•	•	•	•
280	32,5	12,5	•	•	•	•
290	37,5	17,5	•	•	•	•
300	•	22,5	•	•	•	•
310	•	27,5	7,5	•	•	•
320	•	32,5	12,5	•	•	•
330	•	37,5	17,5	•	•	•
340	•	•	22,5	•	•	•
350	•	•	27,5	7,5	•	•
360	•	•	32,5	12,5	•	•
370	•	•	37,5	17,5	•	•
380	•	•	•	22,5	•	•
390	•	•	•	27,5	7,5	•
400	•	•	•	32,5	12,5	•
410	•	•	•	37,5	17,5	•
420	•	•	•	•	22,5	•
430	•	•	•	•	27,5	7,5
440	•	•	•	•	32,5	12,5
450	•	•	•	•	37,5	17,5
460	•	•	•	•	•	22,5
470	•	•	•	•	•	27,5
480	•	•	•	•	•	32,5
490	•	•	•	•	•	37,5

Models

Peak Triple, Peak Quattro, Peak Quattro-XL, Peak Quattro-XXL



Peak-Triple - 47



Peak-Triple - 57



Peak-Quattro - 72



Peak-Quattro - 90



Peak-Quattro - 110



Peak-Quattro-XL - 72



Peak-Quattro-XL - 90



Peak-Quattro-XL - 110



Peak-Quattro-XXL - 72

Facts

Peak Triple, Peak Quattro, Peak Quattro-XL, Peak Quattro-XXL

Table heights incl. top of 25mm

Peak - Tripel

Dimensions cm

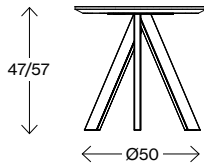

Peak - Quattro

Dimensions cm

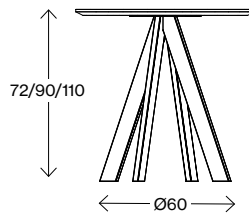

Peak - Quattro - XL

Dimensions cm

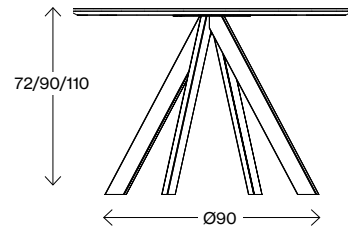

Peak-Quattro-XXL

Dimensions cm

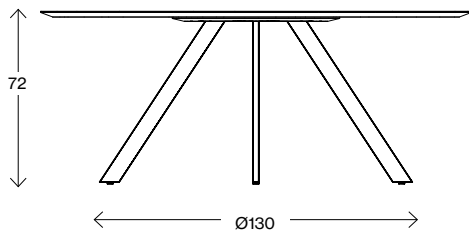

Recommended combinations

Peak Triple, Peak Quattro, Peak Quattro-XL, Peak Quattro-XXL

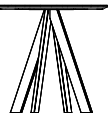
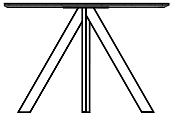
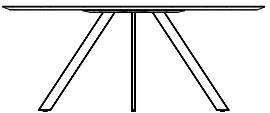
				
Top	Peak-Triple	Peak-Quattro	Peak-Quattro-XL	Peak-Quattro-XXL
Ø50	47/57	-	-	
Ø60	47/57	72/90/110		
Ø75	-	72/90/110		
Ø90/Ø100	-	-	72/90/110	
Ø110/Ø120	-	-	72/90/110	
Ø128				72
Ø150-Ø200				72
60x70	-	72/90/110	-	
70x70	-	72/90/110	-	

Electric equipment

When ordering these products in combination with table tops, the cost for cut out is included in the price. Schuko coupling is delivered as standard.



Powerdot Micro
1 USB-A & 1 USB-C (15,5W/5V/3,1A)
Black / white



Powerdot Mini USB
2 USB-C PD (30W/20V/1,5A)
Black / white



Powerdot Mini Electric
1 power (type F, Schuko)
Black / white



Powerdot Midi
1 power (type F, Schuko) &
1 USB-C PD (30W/20V/1,5A)
Black / white

Connect multiple Powerdots in series using a single connection cable. Series-connected Powerdots are available on request.

Powerdot package

Complete with table cover that can be opened from two sides, spacious tray with plenty of space for connectors, Powerdots, textile bag and power strip. The textile bag hides hanging cables in an efficient and discreet way. In combination with Powerdot Electric/Powerdot Electric-USB.

Powerdot package for Peak: Textile bag is not included as cables are stored in the "Peak connection" fixing plate, however, a distance plate is sent with it.



Powerdot Electric
1 power (type F, Schuko) &
4 cable holes
Black



Powerdot Electric USB + charger
1 power (type F, Schuko), 1 USB-A, 1
USB-C (max 60w, 5/9/12/20V, max 3A) &
2 cable holes. Charger for Powerdot.
Black



Powerdot package 31x15cm
Cover and tray in black, white or silver

Powerdot package, 2 Powerdot Electric (2 power)

Powerdot package, 2 Powerdot Electric USB
(2 power, 2 USB-A, 2 USB-C)

Powerdot package, 1 Powerdot Electric and
1 Electric USB (2 power, 1 USB-A, 1 USB-C)

Cable hatch

Practical Cable hatch in the same material as the table top for data and electrical connection, customized to the customer's wishes. We can also provide a practical mounting tray, L370xW200 in black. Contact Johanson support for info.



Facts

Peak in detail

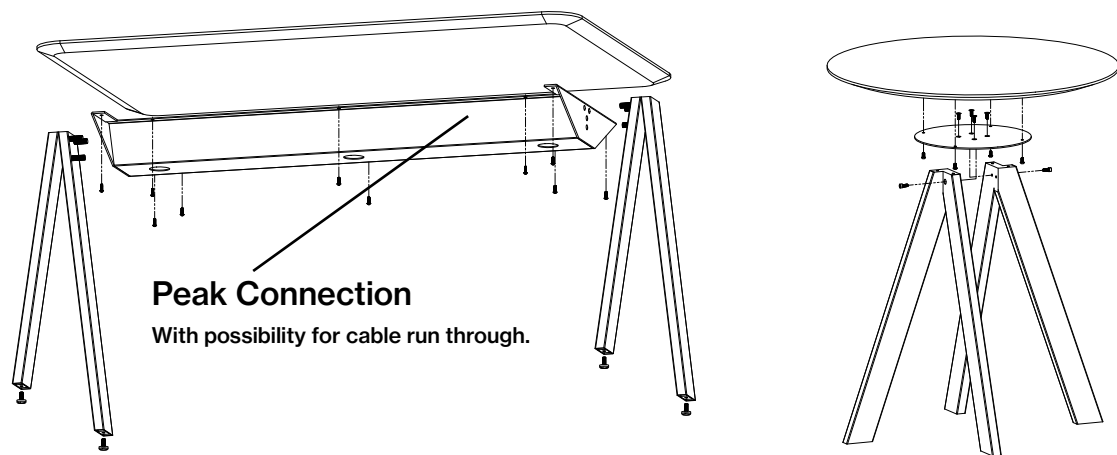

Facts

Material

- 20-50% Recycled Swedish steel
- Underneath each leg there is a plastic glider

Certifikat



BIM -objects can be downloaded
www.johansondesign.com



3D Max



Archicad



Revit



Autocad 2D



Autocad 3D



Sketchup

 pCon

Recycling

All steel parts are recyclable.

Before we finish the chrome/lacquer all grease/oil is removed by alkaline wash and then sent for destruction. The lacquering is produced by electrostatic epoxy powder coating that gives a minimum of waste. The electrostatic chrome (chrome 3) is recyclable. The plastic parts that are used are recyclable by grinding. All upholstery and frames of synthetic material are totally without C.F.C. emissions. All glue is water based.

Models

Peak Bench



Peak Bench 46-120



Peak Bench 46-120 Table



Peak Bench 65-120



Peak Bench 46-180



Peak Bench 46-180 Table



Peak Bench 46-180



Peak Bench 46-240



Peak Bench 46-240 Table



Peak Bench 65-240

Colour

Multicolour - Finish RAL

Take part in Johanson's color range, 399 variants of different finishes are offered as standard on steel frames and metal details. Choose from all 192 RAL colors, alternatives are available both as solid finish (gloss 72) or Structure finish which has a matte, slightly textured elegant surface. In addition, 15 RAL colors with pearl finish are offered.

For all colours see www.johansondesign.com

192 Solid collection (gloss 72)

192 Structure collection (matte, textured surface)

15 Pearl finish collection



Table top



Basic

Straight edge with thickness 25mm.



Discus

Chamfered edge with thickness 25mm. MDF with laminate or veneer in different executions.

Other

Besides our standard range of veneer, laminate, stain and lacquer-colours we can offer customized solutions.

Table tops



Discus

Chamfered edge with thickness 25mm. MDF with laminate or veneer in different executions.

Finish	Description	Edge
White laminate	F1040 MAT Alpino RAL 9010	Discus edge, natural lacq. MDF
Black laminate	F2253 MAT Diamond black RAL 9011	Discus edge, natural lacq. MDF
Light grey laminate	F7927 MAT Folkestone NCS S 2500-N	Discus edge, natural lacq. MDF
Oak laminate	F5374 NAT Elegant oak	Discus edge, natural lacq. MDF
Birch laminate	F7921 MAT Birch	Discus edge, natural lacq. MDF
Wenge laminate	F1614 MAT Punga Punga Wood	Discus edge, natural lacq. MDF
Walnut laminate	F5150 MAT American Walnut	Discus edge, natural lacq. MDF
Ash laminate	F8843 NAT Natural Ash	Discus edge, natural lacq. MDF
Oak veneer	Clear lacquered oak veneer	Discus edge, natural lacq. MDF
Birch veneer	Clear lacquered birch veneer	Discus edge, natural lacq. MDF
Ash veneer	Clear lacquered ash veneer	Discus edge, natural lacq. MDF
Formica Collection Colors	Any color from Formica Collection Colors:	Discus edge, natural lacq. MDF
White laminate	F1040 MAT Alpino RAL 9010	Discus edge, white lacquered MDF
Black laminate	F2253 MAT Diamond black RAL 9011	Discus edge, black MDF
Black stained oak veneer	Black stained lacquered oak veneer	Discus edge, black stained MDF
White stained oak veneer	Oak veneer white pigmented lacquer	Discus edge, white stained MDF
Black stained ash veneer	Black stained lacquered ash veneer	Discus edge, black stained MDF
White stained ash veneer	Ash veneer white pigmented lacquer	Discus edge, white stained MDF
Abet Laminati	Rocks 557 Papier	Discus edge, natural lacq. MDF
Abet Laminati	Rocks 1451 Papier	Discus edge, natural lacq. MDF
Abet Laminati	Rocks 596 Climb	Discus edge, natural lacq. MDF
Fenix NTM laminate	0718 Grigio Londra	Discus edge, black MDF
Fenix NTM laminate	0720 Nero Ingo	Discus edge, black MDF
Fenix NTM laminate	0724 Grigio Bromo	Discus edge, black MDF
Fenix NTM laminate	0752 Grigio Antrim	Discus edge, black MDF
Formica Collection True Scale	F3458 Travertine Silver AR Plus	Discus edge, natural lacq. MDF
Formica Collection True Scale	F3457 Breccia Paradiso AR Plus	Discus edge, natural lacq. MDF
Formica Collection True Scale	F3476 Jet Sequoia AR Plus	Discus edge, natural lacq. MDF
Formica Collection Patterns	F8832 Elemental Corten AHD	Discus edge, natural lacq. MDF
Formica Collection Colors	Any color from Formica Collection Colors:	Colour lacquered to match laminate



Basic

Straight edge with thickness 25mm.

Finish	Description	Edge
White laminate		Basic edge, white ABS-edge
Black laminate		Basic edge, black ABS-edge
Forbo Desktop	4023 Nero	Basic edge in matching colour
Forbo Desktop	4172 Mauve	Basic edge in matching colour
Forbo Desktop	4132 Ash	Basic edge in matching colour
Forbo Desktop	4179 Smokey Blue	Basic edge in matching colour
Forbo Desktop	4174 Conifer	Basic edge in matching colour
Forbo Desktop	4184 Olive	Basic edge in matching colour
Forbo Desktop	4176 Mushroom	Basic edge in matching colour
Kvadrat Really	Cotton Cream	ABS-edge
Kvadrat Really	Cotton White	ABS-edge

Other

Besides our standard range of veneer, laminate, stain and lacquer-colours we can offer customized solutions.

Facts

Peak Bench

Dimensions cm

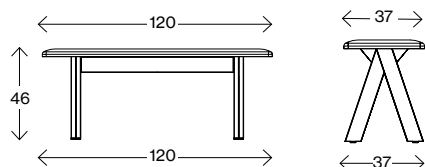

Peak Bench 46 - 120

Weight (kg) -
Volume (m³) 0,20

Dimensions cm

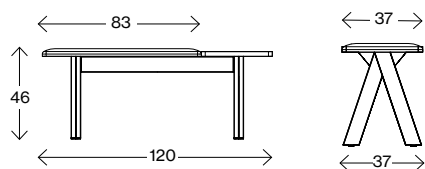

Peak Bench 46 - 120 Table

Weight (kg) -
Volume (m³) 0,20

Dimensions cm

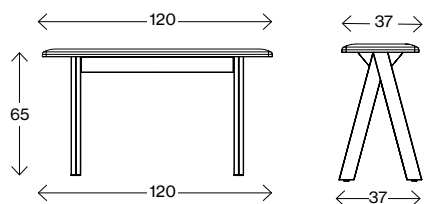

Peak Bench 65 - 120

Weight (kg) -
Volume (m³) 0,29

Dimensions cm

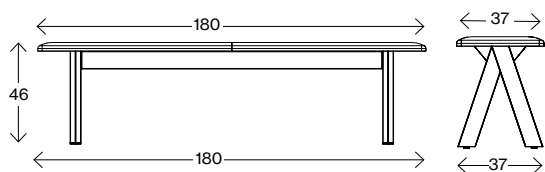

Peak Bench 46 - 180

Weight (kg) -
Volume (m³) 0,31

Dimensions cm

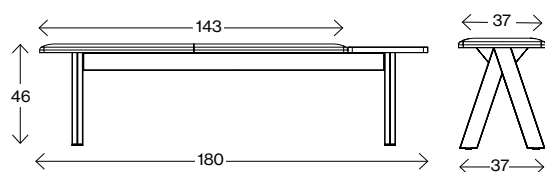

Peak Bench 46 - 180 Table

Weight (kg) -
Volume (m³) 0,31

Facts

Peak Bench

Dimensions cm

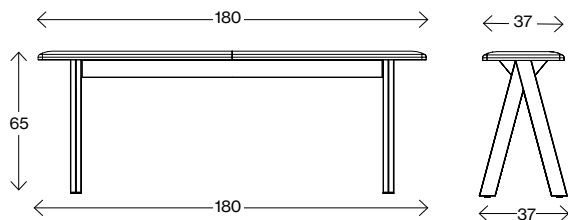

Peak Bench 65 - 180

Weight (kg) -
Volume (m³) 0,43

Dimensions cm

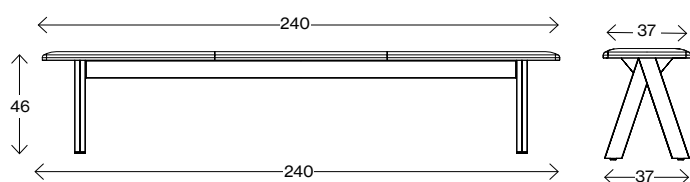

Peak Bench 46 - 240

Weight (kg) -
Volume (m³) 0,41

Dimensions cm

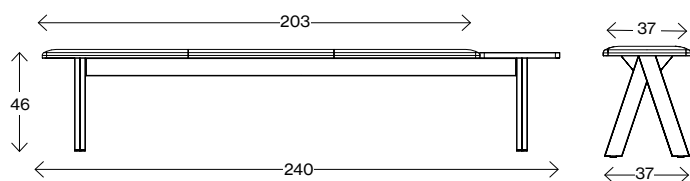

Peak Bench 46 - 240 Table

Weight (kg) -
Volume (m³) 0,41

Dimensions cm

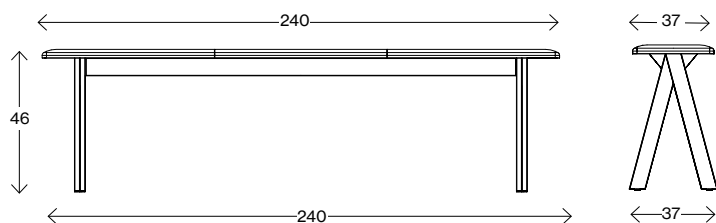

Peak Bench 65 - 240

Weight (kg) -
Volume (m³) 0,41

















JOHANSON

Johanson Design AB | Anders Anderssons Väg 7 | 285 35 Markaryd | Sweden
Tel +46-433 725 00 | www.johansondesign.com