

Family

Robbie

Design – Böttcher & Kayser



JOHANSON



Introduction

The idea behind Robbie was to design a chair that combines stackability with a genuinely attractive form. With this clearly in mind, the focus was on using as few components as possible and giving them a highly distinctive design. The aim was to create a chair that is simple in design, yet by no means anonymous in terms of personality. The eye-catching lines of Robbie attract attention in any setting.



Designer

Böttcher & Kayser is a Berlin-based studio founded in 2007, working in the fields of consumer product, furniture, lighting and interior design. Moritz Böttcher and Nikolaus Kayser have been rewarded with several prestigious awards such as the Interior Innovation Award, several iF Design Awards and numerous Red Dot Awards – including the award, 'Best of the Best' in 2013. Their projects have been published in books and magazines around the world.



Base

- 1 Choose model - base and execution
- 2 Choose model - seat and material, colour and texture
- 3 Choose accessories

Sled base

Swivel base

Four leg base



09-46



03-46



08-46



09-46 with armrests (WA)



03-46 with wheels



Robbie-BS 65



Robbie-BS 80

Seat & Material

1 Choose model - base and execution

2 Choose model - seat and material, colour and texture

3 Choose accessories

Seats



Wooden seat



Half covered seat (HC)



Covered seat (C)



Wooden seat



Covered seat (C)

Colors Wooden seat



Oak veneer



White stained
veneer oak



Black stained
oak veneer



Oak veneer stained
in any RAL color

Seat & Material

1 Choose model - base and execution

2 Choose model - seat and material, colour and texture

3 Choose accessories

Seat - Upholstery materials

Johanson offers a very generous range of fabrics, leather and artificial leather from the most reputable suppliers in the world. Should any other material be desired despite the wide selection, it is also possible to suggest other materials. Johanson does not charge start-up costs for handling non-standard materials.

Multicolour - Finish RAL

Take part in Johanson's color range, 405 variants of different finishes are offered as standard on steel frames and metal details. Choose from all 195 RAL colors, alternatives are available both as solid finish (gloss 72) or Structure finish which has a matte, slightly textured elegant surface. In addition, 15 RAL colors with pearl finish and chrome or polished aluminum are offered.

For all colours see www.johansondesign.com

195 Solid collection (gloss 72)

195 Structure collection (matte, textured surface)

15 Pearl finish collection

Chrome (08, 09- base)

Polished aluminum (03-base).



Accessories

1 Choose model - base and execution

2 Choose model - seat and material, colour and texture

3 Choose accessories



Connector

08-base



Wheels

Wheels for 03-base in black, white and chrome.



Connector

09-base

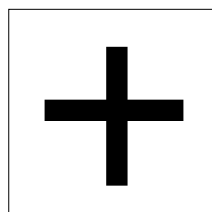

Extra

Felt gliders
Stacking protection



Stacking trolley

Stackability for each chair can be found under facts.

Facts

Material

The seat is made of FSC certified wood and padding is made of polyether/foam. Finished/lacquerd metal.

Fire classification

All products meet Möbelfakta's fire requirements. All polyether/foam are tested to Cal TB 117. All standard fabrics meet EN 1021:1 & 2. Other classification, for example BS 5856 (Crib 5) on request, please contact customer support.

Certificate



Recycling

All steel parts are recyclable. Before we finish the chrome/lacquer all grease/oil is removed by alkaline wash and then sent for destruction. The lacquering is produced by electrostatic epoxy powder coating that gives a minimum of waste. The electrostatic chrome (chrome 3) is recyclable. The plastic parts that are used are recyclable by grinding. All upholstery and frames of synthetic material are totally without C.F.C. emissions. All glue is water based.

BIM - objects can be downloaded

at johansondesign.com



3D Max



Archicad



Revit



Autocad 2D



Autocad 3D



Sketchup



pCon

Facts

Measurements cm

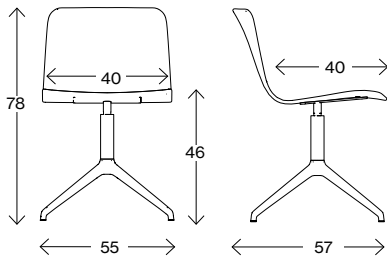

Robbie 03-46*

Weight (kg) 8,5
Volume (m³) 0,27

Measurements cm

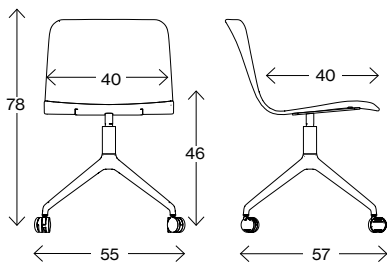

Robbie 03-46 with wheels*

Weight (kg) 8,5
Volume (m³) 0,27

Measurements cm

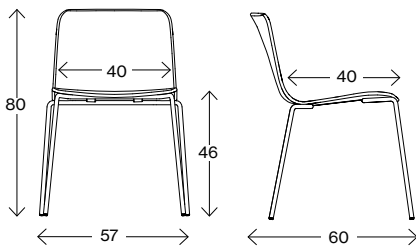

Robbie 08-46*

Weight (kg) 6,0
Volume (m³) 0,25



Measurements cm

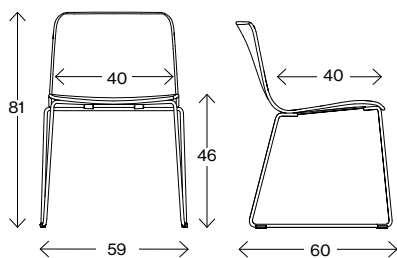

Robbie 09-46*

Weight (kg) 8,0
Volume (m³) 0,25



Measurements cm

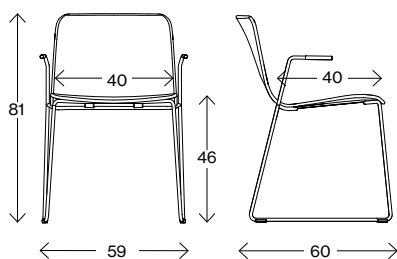

Robbie 09-46 with armrests (WA)*

Weight (kg) 9,0
Volume (m³) 0,25



Facts

Measurements cm

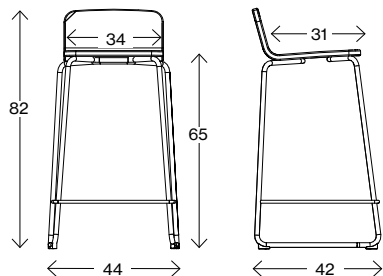

Robbie BS 65+

Weight (kg) 6,0
Volume (m³) 0,192

Measurements cm

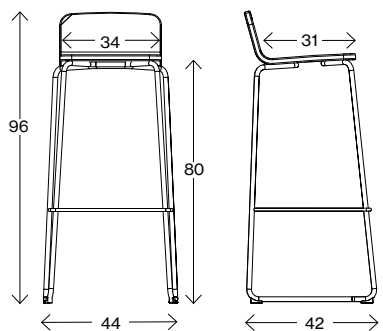

Robbie BS 80+

Weight (kg) 9,0
Volume (m³) 0,243





JOHANSON

Johanson Design AB | Anders Anderssons Väg 7 | 285 35 Markaryd | Sweden
Tel +46-433 725 00 | www.johansondesign.se