

Family
Alice

Design – Alexander Lervik



JOHANSON



Introduction

Saga is one of Alexander Lervik's personal favourites in Johanson's range. At the same time, the seat has been a part he has wanted to develop since the launch, as it lacked the final sense of completion and the self-evident comfort where form and function meet.

The solution was to bring together two ideas that were already established. The seat from the Plus chair

was integrated into Saga. The result is a version where both comfort and form fall into place, and the model is experienced as the complete whole it was always intended to be.

The updated Saga and Saga BS is launched as Alice and Alice BS



Designer

Alexander Lervik is one of Sweden's most well-known designers, collaborating with a number of national and international producers, including Moroso, Zero, Designhouse Stockholm and Johanson. Though his main focus is lighting, furniture and product design, he also creates concepts for hotel and restaurant interiors and collaborates with fashion brands.



Models



Alice 08-46



Alice BS 65



Alice BS 80

Facts

Alice in detail

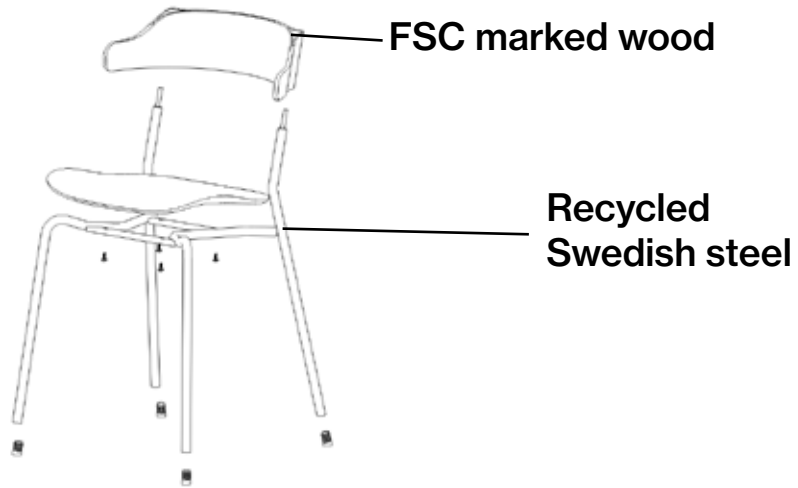

Separable



Material

The seat is made of FSC certified wood and padding is made of polyether/foam. Finished/lacquered metal.

Fire classification

All products meet Möbelfakta's fire requirements. All polyether/foam are tested to Cal TB 117. All standard fabrics meet EN 1021:1 & 2. Other classification, for example BS 5856 (Crib 5) on request, please contact customer support.

Recycling

All steel parts are recyclable. Before we finish the chrome/lacquer all grease/oil is removed by alkaline wash and then sent for destruction. The lacquering is produced by electrostatic epoxy powder coating that gives a minimum of waste. The electrostatic chrome (chrome 3) is recyclable. The plastic parts that are used are recyclable by grinding. All upholstery and frames of synthetic material are totally without C.F.C. emissions. All glue is water based.

Certificate



BIM - objects can be downloaded at

johansondesign.com

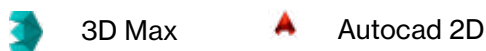

3D Max



Autocad 2D



Archicad



Autocad 3D



Revit



Sketchup



pCon

Material

Seat - Upholstery materials

Johanson offers a very generous range of fabrics, leather and artificial leather from the most reputable suppliers in the world. Should any other material be desired despite the wide selection, it is also possible to suggest other materials. Johanson does not charge start-up costs for handling non-standard materials

Multicolour - Finish RAL

Take part in Johanson's color range, 405 variants of different finishes are offered as standard on steel frames and metal details. Choose from all 195 RAL colors, alternatives are available both as solid finish (gloss 72) or Structure finish which has a matte, slightly textured elegant surface. In addition, 15 RAL colors with pearl finish and chrome are offered.

For all colours see www.johansondesign.com

195 Solid collection (gloss 72)

195 Structure collection (matte, textured surface)

15 Pearl finish collection and chrome.



Material

Back - Wood



Oak



White stained oak



Black stained oak



Oak veneer stained in any RAL color

Plastic seat - colour options



Black RAL 9005
NCS S 9000-N

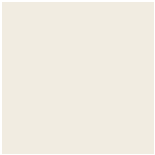

White RAL 9010
NCS S 0502-Y



Green RAL 6013
NCS S 5020-G70Y



Light Grey RAL 7004
NCS S 4000-N



Dark Grey RAL 7012
NCS S 7000-N



Beige RAL 1019
NCS S 4010-Y30R



Wine Red RAL 3005
NCS S 6030-R



Pink RAL 3012
NCS S 3030-Y60R

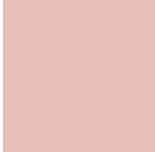

Light Pink
NCS S 1515-Y80R



Red RAL 3016
NCS S 3060-Y80R



Blue RAL 5001
NCS S 6030-B



Yellow RAL 1005
NCS S 2070-Y10R



Hyacinth Blue
RAL 280 40 45



Brick Red
RAL 040 40 40

Above colors for Alice seat shells are standard.
In addition to these, we can offer the seat shells in all other RAL colors.
For more information please contact our customer support.

Facts

Measurements cm

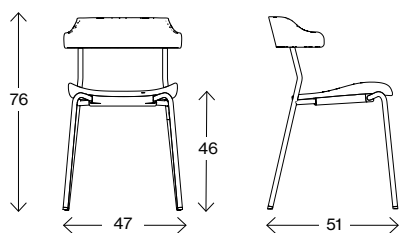

Alice 08-46

Weight (kg) 4,2
Volume (m³) 0,21



Measurements cm

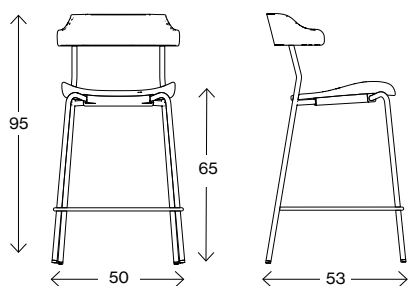

Alice BS 65

Weight (kg) 5,8
Volume (m³) 0,21

Measurements cm

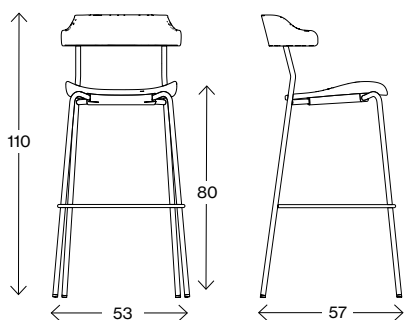

Alice BS 80

Weight (kg) 6,4
Volume (m³) 0,21



JOHANSON

Johanson Design AB | Anders Anderssons Väg 7 | 285 35 Markaryd | Sweden
Tel +46-433 725 00 | www.johansondesign.com