

Family  
**Celsius**

Design – Alexander Lervik



**JOHANSON**



## Introduction

When Studio was launched in 2004, the characteristic “bottle cap” shape in the backrest became a clear part of the chair’s identity. It functioned as a graphic signature and gave the model its own voice in the room, while the shape was complex to produce.

Through a formal update of the backrest, the expression has been simplified and brought closer to its time, while production becomes more rational. The seat’s press tool can be retained unchanged.

An important part of the development is also that the chair can be reupholstered in the future, which extends its lifespan and makes the model more sustainable over time.

The result of the update can be seen in Celsius and Celsius BS.



## Designer

Alexander Lervik is one of Sweden's most well-known designers, collaborating with a number of national and international producers, including Moroso, Zero, Designhouse Stockholm and Johanson. Though his main focus is lighting, furniture and product design, he also creates concepts for hotel and restaurant interiors and collaborates with fashion brands.



# Models

---



Celsius 08-46



Celsius 08-46 WA



Celsius 09-46



Celsius 09-46 WA



Celsius BS-65

Celsius BS-80

# Material

---

## Seat - Upholstery materials

Johanson offers a very generous range of fabrics, leather and artificial leather from the most reputable suppliers in the world. Should any other material be desired despite the wide selection, it is also possible to suggest other materials. Johanson does not charge start-up costs for handling non-standard materials.

## Multicolour - Finish RAL

Take part in Johanson's color range, 405 variants of different finishes are offered as standard on steel frames and metal details. Choose from all 195 RAL colors, alternatives are available both as solid finish (gloss 72) or Structure finish which has a matte, slightly textured elegant surface. In addition, 15 RAL colors with pearl finish and chrome are offered.

For all colours see [www.johansondesign.com](http://www.johansondesign.com)

**195 Solid collection** (gloss 72)

**195 Structure collection** (matte, textured surface)

**15 Pearl finish collection** and chrome.



# Accessories

---



## Connector

Celsius 08-base



## Stacking trolley

Stackability for each chair can be found under facts.



## Connector

Celsius 09-base

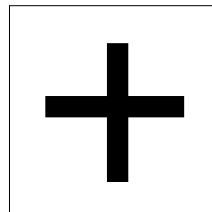

## Extra

Felt gliders  
Stacking protection (standard)

# Facts

---

## Material

The seat is made of FSC certified wood and padding is made of polyether/foam. Finished/lacquered metal.

## Fire classification

All products meet Möbelfakta's fire requirements. All polyether/foam are tested to Cal TB 117. All standard fabrics meet EN 1021:1 & 2. Other classification, for example BS 5856 (Crib 5) on request, please contact customer support.

## Certificate



## Recycling

All steel parts are recyclable. Before we finish the chrome/lacquer all grease/oil is removed by alkaline wash and then sent for destruction. The lacquering is produced by electrostatic epoxy powder coating that gives a minimum of waste. The electrostatic chrome (chrome 3) is recyclable. The plastic parts that are used are recyclable by grinding. All upholstery and frames of synthetic material are totally without C.F.C. emissions. All glue is water based.

## BIM - objects can be downloaded

at [johansondesign.com](http://johansondesign.com)



3D Max



Archicad



Revit



Autocad 2D



Autocad 3D



Sketchup

 pCon

# Facts

Measurements cm

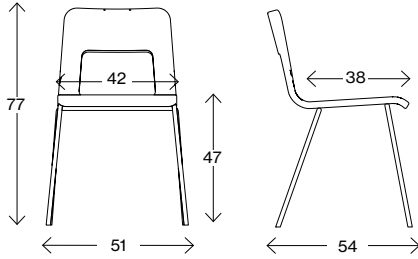

## Celsius 08-46

Weight (kg) 6,0  
Volume (m<sup>3</sup>) 0,266

Measurements cm

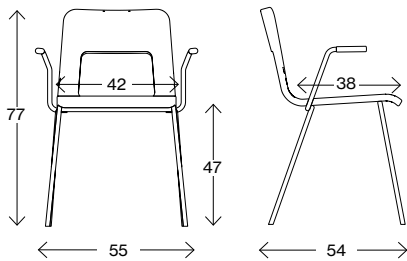

## Celsius 08-46 WA

Weight (kg) -  
Volume (m<sup>3</sup>) 0,266

Measurements cm

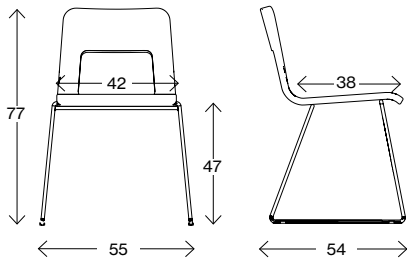

## Celsius 09-46

Weight (kg) 7,5  
Volume (m<sup>3</sup>) 0,266

Measurements cm

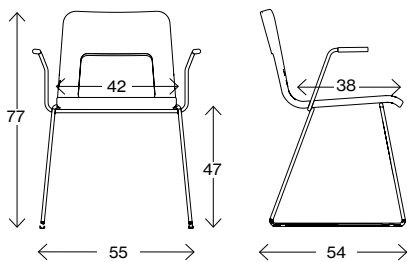

## Celsius 09-46 WA

Weight (kg) -  
Volume (m<sup>3</sup>) 0,266

The facts also apply to model with armrest

# Facts

---

Measurements cm

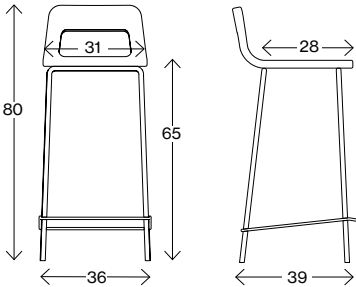

**Celsius BS 65**

Weight (kg) 6,2  
Volume (m<sup>3</sup>) 0,138

Measurements cm

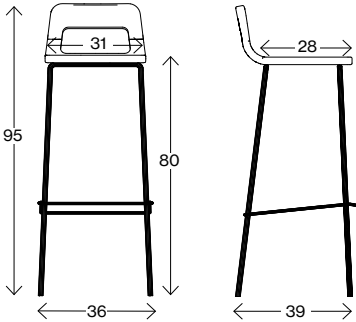

**Celsius BS 80**

Weight (kg) 6,7  
Volume (m<sup>3</sup>) 0,157



# JOHANSON

---

Johanson Design AB | Anders Anderssons Väg 7 | 285 35 Markaryd | Sweden  
Tel +46-433 725 00 | [www.johansondesign.com](http://www.johansondesign.com)